



Catalogue Measurement Equipment



Check Box S6



- Chart recorder for data logging of up to 4/8/12 sensors
- 7" Color display with touch panel
- Ethernet connection
- 4 GB Data memory

Page 8-11

Check Box S1-S5



- Chart recorder for data logging of up to 2/4 sensors
- 3,5" Color display with touch panel
- Option: Ethernet connection
- Option: 4 GB Data memory

Page 12-15

Check Box M6



- Chart recorder for data logging of up to 4/8/12 sensors
- 7" Color display with touch panel
- In a sturdy case for the field use
- Ethernet connection
- 4 GB Data memory

Page 20-23

Check Box M1-5



- Chart recorder for data logging of up to 2/4 sensors
- 3,5" Color display with touch panel
- In a sturdy case for the field use
- Integrated Li-Ion battery
- Ethernet connection
- 4 GB Data memory

Page 24-27

Check Box 500 mobile



- Portable handheld device
- 1 sensor input
- 3,5" Color display with touch panel
- Integrated Li-Ion battery
- 4 GB Data memory

Page 28-29

Suitable sensors for Check Box S1-6

Page 16-18

Suitable sensors for mobile devices Check Box S1-6
Check Box 500 mobile

Page 30-33



PDP Check M/ Mplus



- Mobile dew point device
- Meas. range $-80...+50^{\circ}\text{Ctd}$ pressure dew point
- 3,5" Color display with touch panel
- Integrated Li-Ion battery
- 4 GB Data memory

Page 34-35

PDP Sens 1/ 2



- Dew point sensor for measurement of residual moisture in compressed air and gases
- Meas. range $-80...+20^{\circ}\text{Ctd}$ or $-20...+50^{\circ}\text{Ctd}$
- 4...20 mA analogue output and/or Modbus-RTU

Page 36

PDP Check S



- Plug-in dew point set
- Meas. range: $-80...+20^{\circ}\text{Ctd}$ or $-20...+50^{\circ}\text{Ctd}$
- 2 Alarm relays (freely adjustable)
- 4...20 mA analogue output

Page 37

PDP Check S3/ S4



- Plug-in dew point set
- Option: integrated data logger dew point monitoring
- Option: Ethernet interface
- 3,5" Color display with touch panel

Page 38-39

Accessories for dew point measurement / calibration

Page 40-44



Flow Check Universal



- Flow meter as a insertion version
- Easy installation and removal under pressure without line interruption
- Applicable in existing pipes from 1/2" to DN 1000

Page 48-49

Flow Check with flange



- Inline flow meter with flange
- DN 15 to DN 80

Page 50-51

Flow Check with thread



- Inline flow meter with thread
- 1/4" to 2"

Page 52-53

**Accessories for Flow Measurement / Calibration /
Measuring ranges for different gases**

Page 54-58



Leak Check Pro 1/ Pro 2



- Leak detector with camera
- shows leakage rate in l/min and costs in Euro
- USB interface for data transfer into the evaluation software PMH Leak Reporter
- Special accessories

Page 72-76

Leak Check



- Low-price leak detector

Page 78-79

Int. Compressor Service

Company: Kragl + Lex
Project: Datenimport 2018-04-04T09:34:51.861Z

Report created at: 04-04-2018 11:52
from: Matthew Smith

Leakages

Project master data:
costBase: 19.00 €
costTime: 8760

Image	Building Place Leak Tag	Date Time	Volume loss	Costs / Year	CO2 Tons / Year	Comment action measures Responsible	Status	Priority
	Neuer Gartenweg 2 Flansch Nr. 3 - O4 15 003	04-04-2018 11:29:42	10.548 l/min	105.30 €	0.58	SEALING		
	Neuer Gartenweg 2 Machine 23 004	04-04-2018 11:31:19	21.528 l/min	214.89 €	1.18	Coupling		
	Neuer Gartenweg 2 Machine 23 004	04-04-2018 11:32:35	2.987 l/min	29.83 €	0.17	Piping		
			2.26.06 l/min	2.260.17 €	2 1.94			

PMH Leak Reporter

- Creates a detailed ISO 50001 report
- Provides an illustrated overview of the leakages found and their savings potential

Page 75



PMH Basic



- Data evaluation as a graph or in table form
- Reading the measurement data of all Pneumatech data loggers / paperless recorders via USB or Ethernet



Page 80-83



Check Box S6 -

Intelligent chart recorder for compressed air and gases

Measurement - control - indication - alarm - recording - evaluation

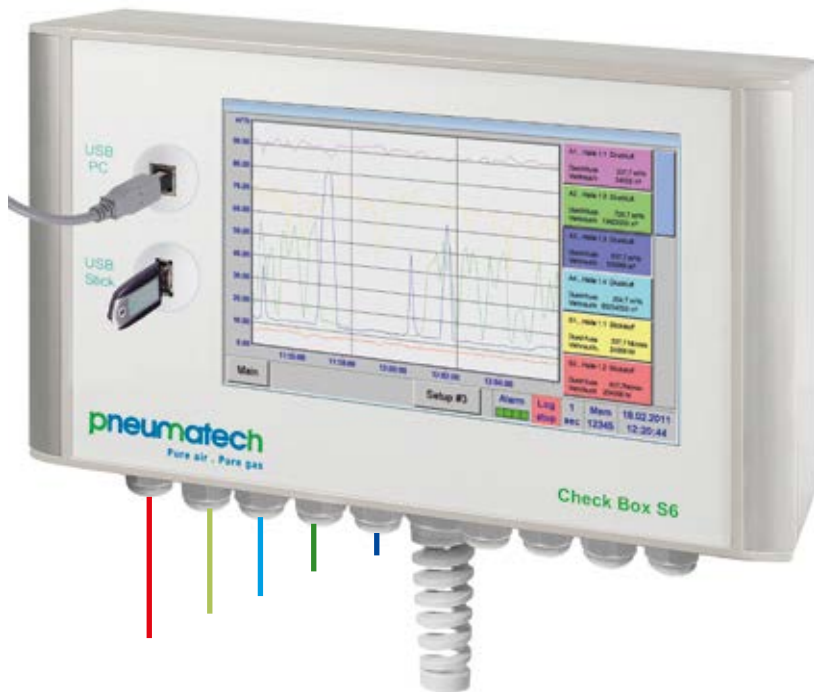

Advantages at a glance:

- Clear layout: 7" color screen with touch panel...
- Versatile: Up to 12 optional sensors can be connected...
- Suitable for industrial applications: Metal housing IP 65 or panel mounting
- Data available through world wide web: Network-compatible and remote transmission via webserver
- Intelligent: Daily/weekly/monthly reports...
- Mathematical function for internal calculations
- Totalizer function for analogue signals
- ... Saves time and costs during installation

Check Box S6 - the intelligent chart recorder of the next generation

From recording of the measured data, indication on a big color screen, alerting, storage up to remote read-out via webserver... this is all possible with Check Box S6. By means of the webserver software alarms can be sent via SMS or e-mail.

All measured values, measured curves and threshold exceeding are indicated. The curve progressions from the beginning of the measurement can be viewed by an easy slide of the finger.

Daily/weekly/monthly reports with costs in € and counter reading in m³ for each consumption sensor are completing the sophisticated system concept. The big difference to ordinary paperless chart recorders reveals in the easy initiation and in the evaluation of the measured data. All sensors are identified directly and powered by Check Box S6. Everything is matched and tuned.

Mathematical function for internal calculations, e.g. the typical figures of a compressed air plant:

- costs in € per generated m³ air
- kWh/m³ generated air
- consumption of single lines including summation

Totalizer function for analogue signals (e.g. 0/4...20 mA, 0...10 V). In case of third-party sensors which e.g. only give a 4...20 mA signal for the actual flow in m³/h a total counter reading in m³ can be generated by means of the totalizer function.

No time consuming studying of the instruction manual... this saves time. Internal voltage supply of all sensors, no wiring of external mains units ... this saves additional costs.



Flow sensors for compressed air and gases

- Installation and removal under pressure via standard 1/2" ball valve
- A safety ring avoids the uncontrolled ejection in case of installation/removal under pressure
- Usable for different gases: compressed air, nitrogen, argon, CO₂, oxygen...



Dew point sensors

- Extremely long-term stable
- Quick adaption time
- Large measuring range (-80° to +20° Ctd)
- For all driers: Desiccant driers, membrane driers, refrigeration driers
- Easy installation under pressure via the standard measuring chamber with quick coupling



Pressure sensors

- Large selection of pressure sensors with different measuring ranges for each measuring purpose
- Quick installation under pressure by quick coupling
- Pressure sensors 0 - 10/16/40/100/250/400/600 bar overpressure
- Pressure sensors -1 - +15 bar (under-/overpressure)
- Differential pressure 0...1,6 bar
- Absolute pressure 0-1.6 bar (abs.)



- Large selection of temperature sensors e.g. for measurement of the ambient temperature or gas temperature
- Pt100 (2-wire or 3-wire)
- Pt1000 (2-wire or 3-wire)
- KTY sensors
- Temperature sensors with measuring transducer (4-20 mA output)



Temperature sensors



- Monitoring the compressed air according to ISO 8773
- Residual oil, particle, residual moisture



Compressed air quality measurement

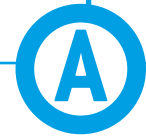

- PMH ENERIUM 30 current/effective power meters for panel mounting with external current transformer for big machines and plants
- External current transformers for encompassing the phases (max. 2000 A)
- Measures KW, kWh, cos phi, kVar, kVA
- Data transfer Check Box S6 via Modbus



Current/effective power meters

By means of the intelligent chart recorder Check Box S6, all measuring data of a compressor station can be recorded, indicated and evaluated.

At 12 freely assignable sensor inputs all our sensors can be connected as well as any optional third-party sensors and meters with the following signal outputs:

4-20 mA, 0-20 mA | 0-1 V / 0-10 V / 0-30 V | Pt 100 (2- or 3-wire), Pt 1000 (2- or 3-wire), KTY | pulse outputs (e.g. of gas meters) frequency output | Modbus protocol.



Measured values, statistics, curves with the 7" color screen touch panel

A1 Compressed Air		A2 Compressed Air		A3 Compressed Air		A4 Compressed Air	
A1a	237.7 m ³ /h	A2a	729.702 m ³ /h	A3a	537.0 m ³ /h	A4a	254.7 m ³ /h
--	34106 m ³	--	13423271 m ³	--	155132 m ³	--	55234063 m ³
B1 Nitrogen		B2 Nitrogen		B3 Nitrogen		B4 Nitrogen	
B1a	337.7 ltr/min	B2a	657.7 ltr/min	B3a	15.7 ltr/min	B4a	237.7 ltr/min
--	27734 ltr	--	240641 ltr	--	34131 ltr	--	235322 ltr
C1 Oxygen		C2 Oxygen		C3 Oxygen		C4 Oxygen	
C1a	17.7 ltr/min	C2a	37.7 ltr/min	C3a	223.7 ltr/min	C4a	75.8 ltr/min
--	4080 ltr	--	234108 ltr	--	3749 ltr	--	43584 ltr

Zurück Virtuelle Kanäle Alarm Log show days, ltr... 24.03.2014 16:41:52

Real time measured values

All measured values can be seen at a glance. Threshold exceeding are indicated in red color. A „measuring site name“ can be allocated to each sensor.



Graphic display

This display replaces the former evaluation of ordinary paper chart recorders and offers lots of advantages. The time axis can be moved by a finger slide. The „zoom function by finger movement“ which enables an analysis of peak values is unique.

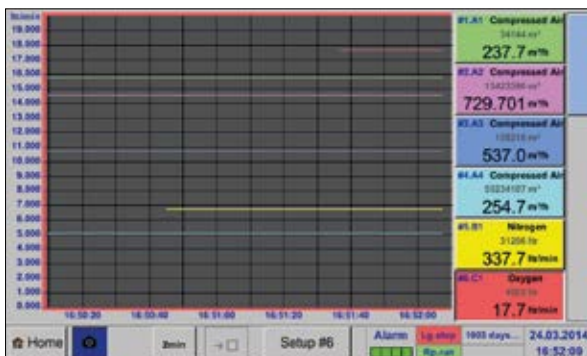

Actual measurement values and graphic

Additionally to the measurement curves the real time value is indicated as well.

*** Consumption report ***

Month/Year	Consumption per month m ³	Costs €	max value m ³ /h	min value m ³ /h	average m ³ /h	Total €
2010 May	7257	109	3.7	35.8	15.8	308
2010 June	9530	143	3.8	36.1	18.9	402
2010 July	7325	110	3.9	37.2	14.5	327
2010 August	8099	121	3.9	37.1	16.1	353
2010 September	7842	118	3.9	36.8	15.6	367
2010 October	6167	93	3.9	37.3	12.2	291
2010 November	9030	136	3.9	37.6	17.9	311
2010 December	9062	136	3.9	37.5	18.0	388
2010 Total	97953	1469	3.8	37.1	16.3	4164
2011 January	8880	133	3.6	37.7	17.6	412

Home Day/Week Week Month/Year

Statistic and reports

Different to ordinary chart recorders the Check Box S6 offers not only the recording of the measured data but also the evaluation of all flow sensors optionally as daily/weekly/monthly report at the push of a button.

It is no longer necessary to read-out the counter and transfer the values manually into a list. The reports can be imported to every PC into Excel® by means of a USB stick and after that they can be printed out without any additional software. This saves time and money and simplifies the evaluation enormously.



Technical data of the Check Box S6

TECHNICAL DATA Check Box S6	
Dimensions of housing:	280 x 170 x 90 mm, IP 65
Connections:	18 x PG 12 for sensors and supply
Version panel mounting:	Cutout panel 250 x 156 mm
Weight:	7.3 Kg
Material:	Die cast metal, front screen polyester
Sensor inputs:	<ul style="list-style-type: none"> • 4/8/12 sensor inputs for analogue and digital sensors freely allocatable. See options • Digital PMH sensors for dew point and consumption with SDI interface FA/VA series, digital third-party sensors RS 485 / Modbus RTU, other bus systems realizable on request. • Analogue PMH Sensors for pressure, temperature, clamp-on ammeters pre-configured. • Analogue third-party sensors 0/4...20 mA, 0...1/10/30V, pulse, Pt 100 / Pt 1000, KTY
Power supply for sensors:	24 VDC, max. 130 mA per sensor, integrated mains unit max. 24 VDC, 25 W. In case of version 8/12 sensor inputs, 2 integrated mains units each max. 24 VDC, 25 W.
Interfaces:	USB stick, Ethernet / RS 485 Modbus RTU / TCP, SDI other bus systems on request, WEB server optionally
Outputs:	<ul style="list-style-type: none"> • 4 relays (changeover contact 230 VAC, 6 A), alarm management, relays freely programmable, collective alarm • Analogue output, pulse in case of sensors with own signal output looped, like e.g. VA/FA series
Memory card:	Memory size 4 GB SD memory card standard
Power supply:	100...240 VAC / 50-60 Hz, special version 24 VDC
Color screen:	7" touch panel TFT transmissive, graphics, curves, statistics
Accuracy:	see sensor specifications
Operating temperature:	0...50°C
Storage temperature:	-20...70°C
Optionally:	Webserver
Optionally:	Option „energy and flow report“ statistics, daily/weekly/monthly report

DESCRIPTION	ORDER-NO.	INPUT SIGNALS
Check Box S6 - intelligent chart recorder in basic version (4 sensor inputs)	2255332462	Current signal: (0...20mA/ 4...20mA) internal or external power supply Measuring range 0...20 mA Resolution 0.0001 mA Accuracy $\pm 0.03 \text{ mA} \pm 0.05 \%$ Input resistance 50 Ω Voltage signal: (0...1 V) Measuring range 0...1 V Resolution 0.05 mV Accuracy $\pm 0.2 \text{ mV} \pm 0.05 \%$ Input resistance 100 k Ω Voltage signal: (0...10 V / 30 V) Measuring range 0...10 V Resolution 0.5 mV Accuracy $\pm 2 \text{ mV} \pm 0.05 \%$ Input resistance 1 M Ω RTD Pt 100 Measuring range -200...850°C Resolution 0.1°C Accuracy $\pm 0.2^\circ\text{C}$ (-100...400°C) $\pm 0.3^\circ\text{C}$ (further range) RTD Pt 1000 Measuring range -200...850°C Resolution 0.1°C Accuracy $\pm 0.2^\circ$ (-100...400°C) Pulse Measuring range min. pulse length 500 μs frequency 0...1 kHz max. 30 VDC
Option: 4 additional sensor inputs for Check Box S6	2255332463	
Option: 8 additional sensor inputs for Check Box S6	2255332464	
Option: Integrated webserver	2255460218	
Option: „energy and flow report“ statistics, daily/weekly/monthly report	2255460220	
Option: version for panel mounting	2255332465	
Option: power supply 24 VDC (instead of 100...240 VAC)	2255332466	
Option: „Mathematics calculation function“ for 4 freely selectable „virtual“ channels, (mathematical functions: addition, subtraction, division, multiplication)	2255460221	
Option: „Totalizer function for analogue signals“	2255460222	
External Gateway Profibus	2255332467	
PMH Basic – data evaluation graphically and in tabular form - reading of the measured data via USB or Ethernet, license for 2 workstations	2255332468	

Matching sensors can be found on pages 16 to 18



Check Box S1-S5 - Chart recorder

for all relevant parameters of compressed air



Standard equipment:

- USB interface
- 3.5" graphic display with touch screen
- Integrated mains unit for supply of the sensors
- 4...20 mA output of all connected active sensors
- Pulse output (for total consumption) in case of flow sensors
- 2 alarm relays (pot.-free switch-over contacts, max. 230 V, 3 A)







Software options:

- Integrated webserver
- Mathematics calculation function
- Totalizer function

Hardware options:

- Integrated data logger
- Ethernet / RS 485 interface
- additional sensor inputs (digital or analogue) selectable

The sensor inputs board 1 and 2 can be selected according to the required sensors (see table pages 16 to 18):

Digital	Digital	Digital	Digital	Analog	Analog	Analog	Analog
m ³ /h, m ³	°Ctd	A, kW/h		bar	A	°C	°C
							4...20 mA 0...20 mA 0...10 V Pulse Pt 100 Pt 1000
Flow sensor	Dew point sensor	Current/effective power meter	Third-party sensors with RS 485	Pressure sensor	Clamp-on ammeter	Temperature sensor	Third party sensor analog output



Panel mounting



Back view

TECHNICAL Check Box S1-S5	
Dimensions:	118 x 115 x 98 mm IP 54 (wall housing) 92 x 92 x 75 mm (panel mounting)
Inputs:	2 digital inputs for FA 5xx resp. VA 5xx
Interface:	USB
Power supply:	100...240 VAC, 50-60 Hz
Accuracy:	Please refer sensor specification
Alarm outputs:	2 relays, (pot.-free)
Options:	
Data logger:	100 million measuring values start/stop time, measuring rate freely adjustable
2 additional sensor inputs:	for connection of pres- sure sensors, tempera- ture sensors, clamp-on ammeters, third-party sensors with 4...20 mA, 0 to 10 V, Pt 100, Pt 1000

DESCRIPTION				ORDER-NO.
Check Box S1-S5 - Mobile chart recorder with graphic display and touch screen		Sensor input 1+2	Sensor input 3+4	
	S 1	Digital	-----	2255330407
	S 2	Digital	Digital	2255330408
	S 3	Digital	Analog	2255330409
	S 4	Analog	-----	2255330410
S 5	Analog	Analog	2255330411	
Options:				
Option: Integrated data logger for 100 million measured values				2255460217
Option: Integrated Ethernet and RS 485 interface				2255460216
Option: Integrated webserver				2255460218
Option: „Mathematics calculation function“ for 4 freely selectable channels, (virtual channels): addition, subtraction, division, multiplication				2255332469
Option: „Totalizer function for analogue signals“				2255332470
External Gateway Profibus for RS 485 interface connection				2255332467
External Gateway Profinet for RS 485 interface connection				2255332743
Further accessories:				
PMH Basic – data evaluation graphically and in tabular form - reading of the measured data via USB or Ethernet, license for 2 workstations				2255332468

INPUT SIGNALS	
Current signal internal or external power supply	(0...20mA/4...20mA)
Measuring range	0...20 mA
Resolution	0.0001 mA
Accuracy	± 0.03 mA ± 0.05 %
Input resistance	50 Ω
Voltage signal	(0...1 V)
Measuring range	0...1 V
Resolution	0.05 mV
Accuracy	± 0.2 mV ± 0.05 %
Input resistance	100 kΩ
Voltage signal	(0...10 V / 30 V)
Measuring range	0...10 V
Resolution	0.5 mV
Accuracy	± 2 mV ± 0.05 %
Input resistance	1 MΩ
RTD Pt 100	
Measuring range	-200...850°C
Resolution	0.1°C
Accuracy	± 0.2°C (-100...400°C) ± 0.3°C (further range)
RTD Pt 1000	
Measuring range	-200...850°C
Resolution	0.1°C
Accuracy	± 0.2° (-100...400°C)
Pulse	minimum pulse length
Measuring range	500 μs frequency 0 ... 1 kHz, max. 30 VDC



Check Box S1-S6

Easy operation via touch screen:

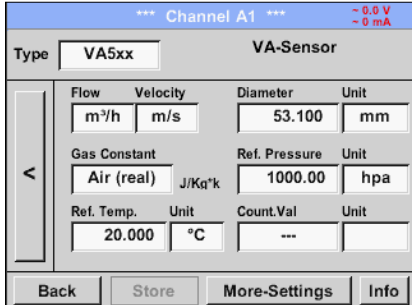

Configuration of flow sensor

In the menu of the Check Box S1-S6, the flow sensor Flow Check can be set to the respective pipe inside diameter. Furthermore, the unit, the gas type and the reference condition can be set. The meter reading can be set to „zero“ if necessary.

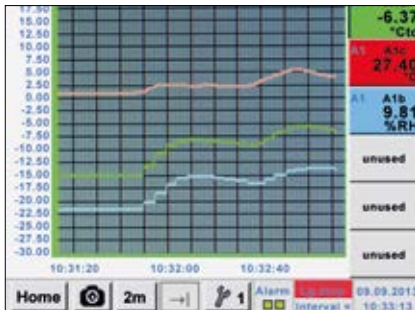

Graphic view

In the graphic view all measured values are indicated as curves. It is possible to browse back on the time axis by a slide of the finger (without data logger maximum 24 h, with data logger back to the start of the measurement).

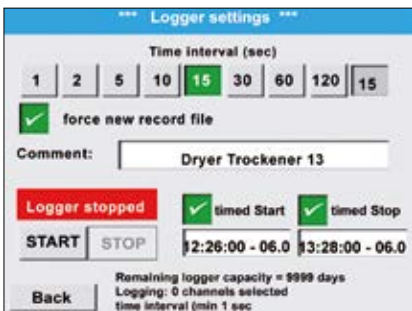

Data logger

With the option „integrated data logger“ the measured values are stored in the Check Box S1-S6. The time interval can be determined freely. It is also possible to set the start time and end time of the data recording. Reading the measured data via USB interface or via the optional Ethernet interface.



Selection of the language

Many languages are already stored in every Check Box S1-S6. The desired language can be selected via the selection button.



All relevant parameters at a glance

In addition to the flow rate in m³ / h, the Check Box S1-S6 also displays other parameters such as total consumption in m³ and speed in m/s.

Webserver

The new webserver with extended features for the chart recorders Check Box S6 and Check Box S1-S5 is available with immediate effect. Users can get direct access to their measured values worldwide (current and historic ones) and display them on their smart phone, tablet or computer. For monitoring of threshold values users can receive an automated „alarm e-mail“.

The new webserver can be ordered as an option with each stationary Check Box S1-S6, but also for their mobile devices. For using the features of the webserver, the Check Box S1-S6 must be set up with it's own IP address within the network.

The webserver provides a website, which displays the measuring values. This website can be accessed from any web browser on each smart phone, tablet or computer via it's unique IP address. This is all possible without the installation of any new or additional software.



View of the real time measured values (graphic table view)



View of the historic measured values as a single chart (time period freely selectable)

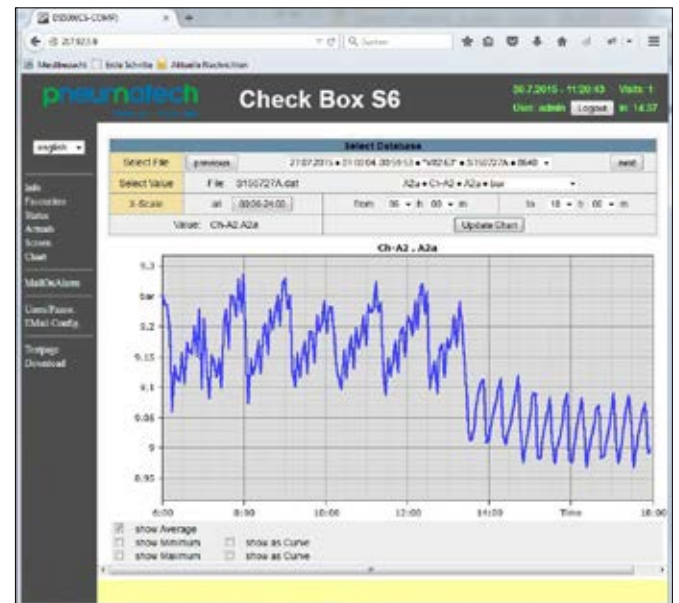

Automated „alarm e-mail“ for threshold value exceedance:

Access authorization

Different groups with different users/passwords can be assigned to different access levels.

Starting the data logger

In case of a stopped data logger the group operator or administrator can start the data logger remotely, via the web server.

PS: The new webserver can be retro fitted to any Check Box S1-S6 already in use.



Suitable sensors for Check Box S1-S6

Flow meters for installation and removal under pressure (insertion type)



Flow Check Universal

FLOW METERS INSERTION TYPE	ORDER-NO.
Flow Check Universal 1 meter in basic version: Standard (92,7 m/s), probe length 220 mm, without display	2255332455

Inline flow meter

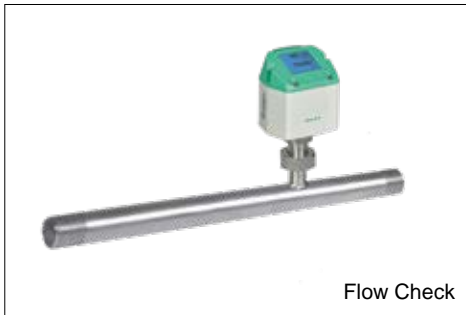

Flow Check

FLOW METERS IN-LINE VERSION	ORDER-NO.
Flow meter Flow Check 1 with integrated measuring section, (R 1/4" DN 8)	2255330393
Flow meter Flow Check 2 with integrated measuring section, (R 1/2" DN 15)	2255330394
Flow meter Flow Check 3 with integrated measuring section, (R 3/4" DN 20)	2255330395
Flow meter Flow Check 4 with integrated measuring section, (R 1" DN 25)	2255330396
Flow meter Flow Check 5 with integrated measuring section, (R 1 1/4" DN 32)	2255330397
Flow meter Flow Check 6 with integrated measuring section, (R 1 1/2" DN 40)	2255330398
Flow meter Flow Check 7 with integrated measuring section, (R 2" DN 50)	2255330399



PDP Sens 1/2

DEW POINT SENSORS:	ORDER-NO.
PDP Sens 2 Dew point sensor, -80...+20 °Ctd incl. factory certificate	2255330413
PDP Sens 1 Dew point sensor, -20...+50 °Ctd incl. factory certificate	2255330412
Standard measuring chamber for compressed air up to 16 bar	2255460229

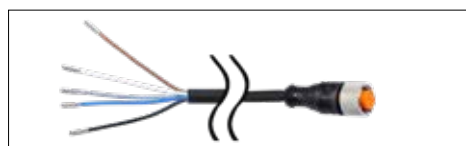

CONNECTION CABLE FOR FLOW METERS/ DEW POINT SENSORS Flow Check Universal , FLOW CHECK AND PDP Sens 1/2:	ORDER-NO.
Connection cable for Flow/ PDP series, 5 m	2255460213
Connection cable for Flow/ PDP series, 10 m	2255460214



PRESSURE PROBES	± 1% ACCURACY	± 0,5% ACCURACY
Standard pressure probe PMH 16, 0...16 bar	2255330414	2255332478
Standard pressure probe PMH 40, 0...40 bar	2255330415	2255332479
Standard pressure probe PMH 1.6, 0...1.6 bar		2255332480
Standard pressure probe PMH 10, 0...10 bar	2255332477	2255332481
Standard pressure probe PMH 100, 0...100 bar		2255332482
Standard pressure probe PMH 250, 0...250 bar		2255332483
Standard pressure probe PMH 400, 0...400 bar		2255332484
Precision pressure probe PMH -1...+15 bar, ± 0.5% accuracy of f. s.		2255332485
Differential pressure probe 1.6 bar diff.		2255332486
Calibration certificate pressure, 5 calibration points for the whole measuring range		2255332487



Inline flow meter

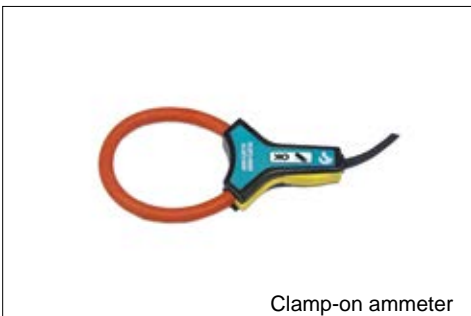
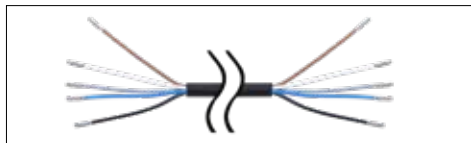

TEMPERATURE SENSORS	ORDER-NO.
Screw-in temperature sensor PT 100 class A, length 300 mm, d = 6 mm, with transmitter 4...20 mA = -50 °C...+ 500 °C (2-wire)	2255332488
Outdoor temperature sensor PT 100 class B (2-wire) in panel mounting (82x55x33 mm) Application range: -50 °C...+80 °C	2255332489
Indoor temperature sensor PT 100 class B (2-wire) in panel mounting with ventilation slots (82x55x33 mm), application range: -50 °C...+80 °C	2255332490
Cable temperature sensor PT 100 class A (4-wire), length: 300 mm, d = 6 mm, -70 ... + 260 °C, 5 m connecting cable PFA with open ends	2255332491
Cable temperature sensor PT 100 class A (4-wire), length: 100 mm, d = 6 mm, -70 ... + 260 °C, 5 m connecting cable PFA with open ends	2255332492
Cable temperature sensor PT 100 class A (4-wire), length: 200 mm, d = 6 mm, -70 ... + 260 °C, 5 m connecting cable PFA with open ends	2255332493
Magnetic surface temperature sensor, magnet 39x26x25 mm, PT 100 class B (2-wire), -30...+ 180 °C, 5m connection cable PFA with open ends	2255332494
Compression fittings: 6mm; G 1/2" teflon clamping ring pressure-tight up to 10 bar. Material: stainless steel, application area: max. + 260 °C	2255332495
Compression fittings: 6mm; G 1/2" teflon clamping ring pressure-tight up to 16 bar. Material: stainless steel, application area: max. + 260 °C	2255332496
Calibration certificate temperature, 2 calibration points	2255332497

CONNECTION CABLES FOR PRESSURE PROBES/TEMP. SENSORS	ORDER-NO.
Connection cable for probes 5 m with open ends	2255332498
Connection cable for probes 10 m with open ends	2255332499

CLAMP-ON AMMETERS	ORDER-NO.
Clamp-on ammeters 0 ... 1000 A TRMS incl. 3 m connection cable with open ends	2255332500
Clamp-on ammeters 0 ... 400 A TRMS incl. 3 m connection cable with open ends	2255332501



PMH ENERIUM 30 - Current/ effective power meter for panel mounting

Measures voltage, current and calculates:

- Active power [kW]
- Apparent power [kVA]
- Reactive power [kVar]
- Active energy [kWh]
- cos phi

All measured data are transmitted digitally (Modbus) to the Check Box S6 and can be recorded there.

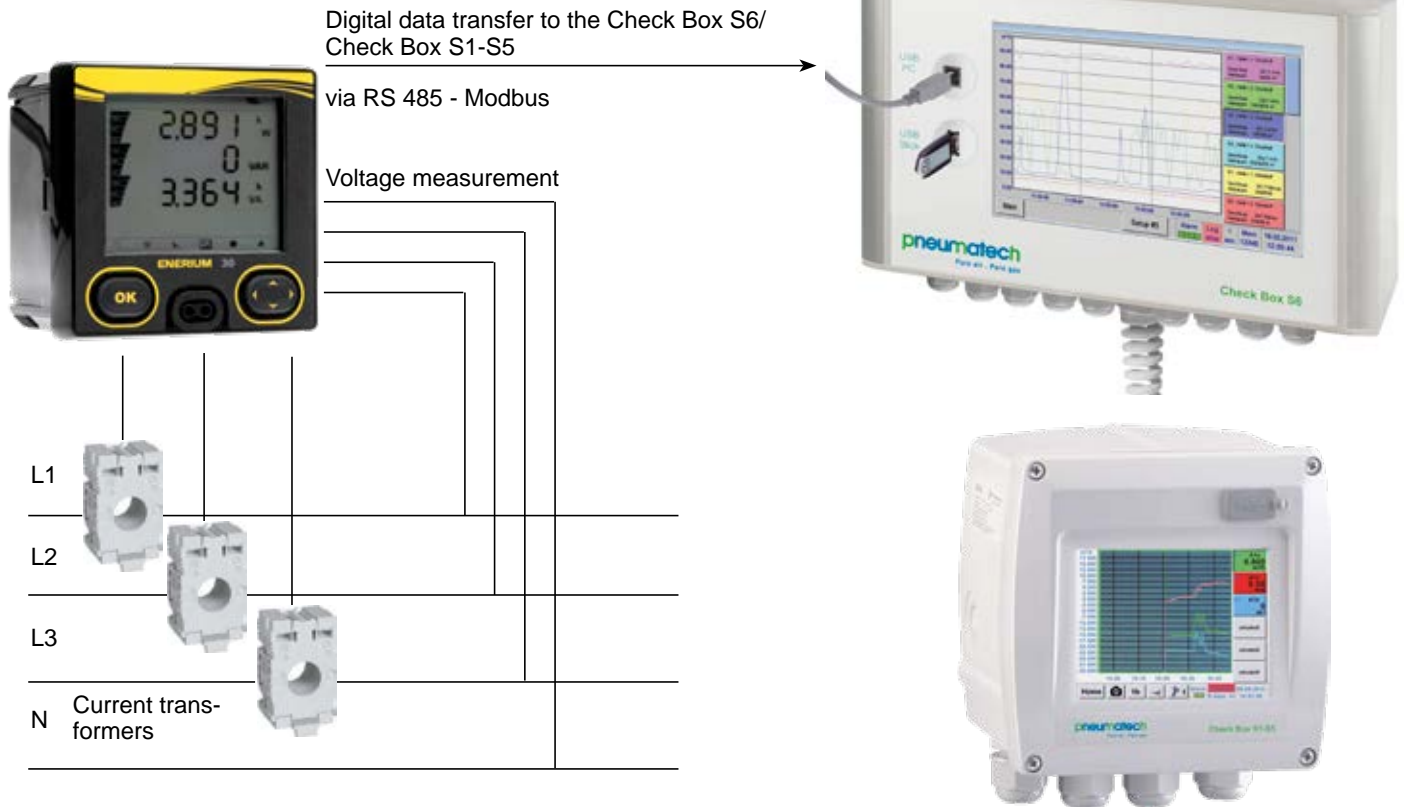

DESCRIPTION	ORDER-NO.
PMH ENERIUM 30 current/effective power meter for panel mounting, with RS485 interface	2255332502
Install-construction for the Enerium 30, on top hat rail	2255332503
Current transformer 100/5 A connectable to current/effective power meter for panel mounting (for cables up to Ø 21 mm)	2255332504
Current transformer 200/5 A connectable to current/effective power meter for panel mounting (for cables up to Ø 21 mm)	2255332505
Current transformer 300/5 A connectable to current/effective power meter for panel mounting (for cables up to Ø 22 mm)	2255332506
Current transformer 500/5 A connectable to current/effective power meter for panel mounting (for cables up to Ø 22 mm)	2255332507
Current transformer 600/5 A connectable to current/effective power meter for panel mounting (for cables up to Ø 22 mm)	2255332508
Current transformer 1000/5 A connectable to current/effective power meter for panel mounting (for current bar up to 65 x 32 mm)	2255332509
Current transformer 2000/5 A connectable to current/effective power meter for panel mounting (for current bar up to 127 x 38 mm)	2255332510
Connection cable for probes 5 m, with open ends	2255332498
Connection cable for probes 10 m, with open ends	2255332499

TECHNICAL DATA ENERIUM 30

Parameters:	Voltage (Volt) Current (Ampere) Cos phi Active power (kW) Apparent power (kVA) Reactive power (kVar) Active energy (kWh) Power frequency (Hz) All parameters are transferred digitally to Check Box S1-S6
Accuracy current measurement:	± 0,5% of 1 to 6 A
Accuracy voltage:	± 0,5% of 50 V to 277 V
Accuracy active energy:	IEC 62053-21 Class 1
Interfaces:	RS 485 (Modbus protocol)
Measuring range:	Voltage measurement max. 480 Volt
Dimensions:	96 x 96 x 74 mm (B x H x T)
Operating temperature:	-10...+55°C



Check Box M6 - intelligent mobile chart recorder

The intelligent mobile chart recorder - energy analysis according to DIN EN ISO 50001
Energy analysis - flow measurement - leakage calculation at compressed air systems

Your advantages at a glance:

- easy operation via 7" color display with touch panel

Versatile:

- Up to 12 sensors/meters connectable also third-party sensors/meters including power supply

Reliable:

- Stores all measured values on a memory card, easy reading-out via USB stick possible

Intelligent energy analysis:

- Daily / weekly / monthly evaluations mathematical functions for internal calculations e. g., the typical key figures of a compressed air system
 - Costs in € per generated m³ air
 - kWh/m³ generated air
 - Flow of single lines including summation



Easy & intuitive
in its operation

Saves time & costs
on installation



Technical data of Check Box M6

TECHNICAL DATA Check Box M6	
Case dimensions	360 x 270 x 150 mm
Weight:	4,5 kg
Material:	Diecast, front foil polyester, ABS
Sensor inputs:	4/8/12 sensor inputs for analogue and digital sensors; freely allocatable. (See options). Digital PMH sensors for dew point and flow with SDI interface Flow/ PDP series, digital third-party sensors RS485 / Modbus RTU. Analogue PMH Sensors for pressure, temperature, clamp-on ammeters preconfigured. Analog third-party sensors 0/4...20 mA, 0...1/10/30V, pulse, Pt 100 / Pt 1000, KTY, counter
Voltage supply for sensor:	24 VDC, max. 130 mA per sensor, integrated mains unit, max. 24 VDC, 25 W. In case of version 8/12 sensor inputs 2 integrated mains unit, each max. 24 VDC, 25 W.
Interfaces:	USB stick, Ethernet / RS 485 Modbus RTU / TCP, SDI other bus systems on request, webserver optionally, GSM module
Memory card:	Memory size 4 GB SD Memory card
Voltage supply:	100...240 VAC / 50-60 Hz
Color display:	7" touch panel TFT transmissive graphics, curves statistics
Accuracy:	Please see sensor specifications
Operating temperature:	0...50°C
Storage temperature:	-20...70°C

INPUT SIGNALS	
Current signal internal or external power supply	(0...20mA/4...20mA)
Measuring range	0...20 mA
Resolution	0.0001 mA
Accuracy	± 0.03 mA ± 0.05 %
Input resistance	50 Ω
Voltage signal	
Measuring range	(0...1 V)
Resolution	0...1 V
Accuracy	0.05 mV
Input resistance	± 0.2 mV ± 0.05 % 100 kΩ
Voltage signal	
Measuring range	(0...10 V / 30 V)
Resolution	0...10 V
Accuracy	0.5 mV
Input resistance	± 2 mV ± 0.05 % 1 MΩ
RTD Pt 100	
Measuring range	-200...850°C
Resolution	0.1°C
Accuracy	± 0.2°C (-100...400°C) ± 0.3°C (further range)
RTD Pt 1000	
Measuring range	-200...850°C
Resolution	0.1°C
Accuracy	± 0.2° (-100...400°C)
Pulse	
Measuring range	Min. pulse length 100 µs frequency 0...1 kHz max. 30 VDC

DESCRIPTION	ORDER-NO.
Intelligent chart recorder Check Box M6-4, 4 sensor inputs	2255332457
Intelligent chart recorder Check Box M6-8, 8 sensor inputs	2255332458
Intelligent chart recorder Check Box M6-12, 12 sensor inputs	2255331721
Option: „integrated webserver“	2255460218
Option: „energy and flow report“ statistics, daily/weekly/monthly report	2255460220
Option: „Mathematics calculation function“ for 4 freely selectable „virtual“ channels, (mathematical functions: addition, subtraction, division, multiplication)	2255460221
Option: „Totalizer function for analogue signals“	2255460222
PMH Basic – data evaluation graphically and in tabular form - reading of the measured data via USB or Ethernet, license for 2 workstations	2255332468
PMH Soft Energy Analyzer for energy and leakage analysis of compressed air stations	2255331729
Connecting cable for pressure, temperature and external sensors to mobile devices, ODU/open ends, 5 m	2255332514
Connecting cable for pressure, temperature and external sensors to mobile devices, ODU/open ends, 10 m	2255332515
Connection cable for Flow/ PDP sensors to mobile devices, ODU/M12, 5m	2255332516
Extension cable for mobile devices, ODU/ODU, 10 m	2255332517
Case for all sensors (dimensions: 500 x 360 x 120 x mm)	2255332518

Further sensors can be found on pages 30 to 33



Check Box M6 - intelligent mobile chart recorder

The intelligent chart recorder of the future - energy analysis according to DIN EN 50001

If we talk about operational costs of compressed air plants we are actually talking about the energy cost as they make up about 70 to 80 % of the total costs of a compressed air plant.

Depending on the size of the plant this means considerable operating costs. Even in smaller plants this may quickly add up to 10.000 to 20.000 € per year. This is an amount which can be considerably reduced - even in the case of well operated and maintained plants. Does this also apply to your compressed air plant? Which actual costs per generated m³ air do you actually have? Which energy is grind due to the waste heat recovery? What is the total performance balance of your plant? How high are the differential pressures of single filters, how high is the humidity (pressure dew point), how much compressed air is used?...

By means of the new intelligent chart recorder Check Box M6 and the suitable sensors and meters all these questions can be answered easily. For example by means of a long-term measurement over 7 days, data recording and evaluation at the PC.



Touch screen



12 sensor inputs

Including voltage supply for all sensors



USB stick



Ethernet connection





Sensors for Check Box M6 / Check Box M1-M5

Flow sensors for compressed air and gases

- Installation and removal under pressure via standard 1/2" ball valve
- A safety ring avoids the uncontrolled ejection in case of installation/removal under pressure
- Usable for different gases: compressed air, nitrogen, argon, CO₂, oxygen



Dew point sensor

- Extremely long-term stable
- Quick adaption time
- Large measuring range (-80° to +20° Ctd)
- For all driers: Desiccant driers, membrane driers, refrigeration driers
- Easy installation under pressure via the standard measuring chamber with quick coupling



Pressure sensors

- Large selection of pressure sensors with different measuring ranges for each measuring purpose
- Quick installation under pressure by quick coupling
- Pressure sensors 0-10/16/40/100/250/400/600 bar overpressure
- Pressure sensors -1 - +15 bar (under-/overpressure)
- Differential pressure 0...1,6 bar
- Absolute pressure 0-1.6 bar (abs:)



Temperature sensors

- Large selection of temperature sensors e.g. for measurement of the ambient temperature or gas temperature
- Pt100 (2-wire or 3-wire)
- Pt1000 (2-wire or 3-wire)
- Temperature sensors with measuring transducer (4-20 mA output)

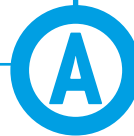

- For the analysis of compressors (load and idle times, energy consumption, on/off cycles) the current consumption of up to 12 compressors is recorded by current clamp
- Measuring range of the current clamps: 0 - 400 A
0 - 1000 A



Clamp-on ammeters

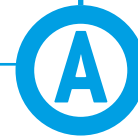

- PMH PM 600 mobile current/active power meter with external current transformers for large machines and plants
- external current transformers for encompassing the phases (100 A or 600 A)
- external magnetic measuring tips for picking up the voltage
- measures KW, kWh, cos phi, kVar, kVA
- Data transmission Check Box M6 via Modbus



Current/effective power meters

By means of the mobile chart recorder **Check Box M6**, all measuring data of a compressor station can be recorded, indicated and evaluated.

At **12 freely assignable sensor inputs** all our sensors can be connected as well as any optional **third-party sensors and meters with the following signal outputs:**

4-20 mA, 0-20 mA I 0-1 V / 0-10 V / 0-30 V I Pt 100 (2- or 3-wire), Pt 1000 (2- or 3-wire), KTY I pulse outputs (e.g. of gas meters) frequency output I Modbus protocol.



Check Box M1-M5 - affordable mobile chart recorder

Energy analysis - flow measurement - leakage calculation at compressed air systems

Advantages at a glance:

- easy operation via 3.5" color display with touch panel
- Internally rechargeable Li-Ion battery - about 8 hours continuous operation

Versatile:

- Up to 4 sensors / meters can be connected, including third-party sensors / counters incl. Power supply

Reliable:

- Stores all measured values on a memory card. Easy reading out via USB stick possible

Intelligent energy analysis:

- Daily / weekly / monthly evaluations mathematical functions for internal calculations e. g., the typical key figures of a compressed air system
 - Costs in € per generated m³ air
 - kWh/m³ generated air
 - Flow of single lines including summation













Up to 4 sensors can be connected including power supply for all sensors



Easy & intuitional
in its operation

Saves time & costs
on installation

Sensors for Check Box M6 / Check Box M1-M5

Digital	Digital	Analog	Analog
<p>Flow meters for compressed air and gases</p> <ul style="list-style-type: none"> Installation and removal under pressure via standard 1/2" ball valve A safety ring avoids the uncontrolled ejection in case of installation/removal under pressure Usable for different gases: compressed air, nitrogen, argon, CO₂, oxygen  	<p>Dew point sensor</p> <ul style="list-style-type: none"> Extremely long-term stable Quick adaption time Large measuring range (-80° to +20° Ctd) For all driers: Desiccant driers, membrane driers, refrigeration driers Easy installation under pressure via the standard measuring chamber with quick coupling  	<p>Pressure sensors</p> <ul style="list-style-type: none"> Large selection of pressure sensors with different measuring ranges for each measuring purpose Quick installation under pressure by quick coupling Pressure sensors 0 - 10/16/40/100/250/400/600 bar overpressure Pressure sensors -1 - +15 bar (under-/overpressure) Differential pressure 0...1,6 bar Absolute pressure 0-1.6 bar (abs.)  	<p>Temperature sensors</p> <ul style="list-style-type: none"> Large selection of temperature sensors e.g. for measurement of the ambient temperature or gas temperature Pt100 (2-wire or 3-wire) Pt1000 (2-wire or 3-wire) Temperature sensors with measuring transducer (4-20 mA output)  
		<p>Clamp-on ammeter</p> 	<p>Current/effective power meters</p> 

By means of the chart recorder **Check Box M1-M5**, all measured data of a compressor station can be recorded, indicated and evaluated. All digital sensors of our product range can be connected to the digital inputs.

Flow meter, dew point sensors, current/effective power meters and third-party sensors with Modbus RS 485 could be connected.

At **analog sensor inputs** third party sensors and meters with the following signal output could be connected: 4-20 mA, 0-20 mA | 0-1 V / 0-10 V / 0-30 V | Pt 100 (2- or 3-wire), Pt 1000 (2- or 3-wire), KTY | pulse outputs (e.g. of gas meters) | frequency output | Modbus protocol.

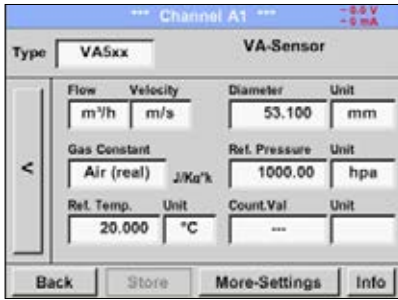

Configuration of flow sensor

In the menu of the Check Box M6/ Check Box M1-M5, the flow sensor Flow Check Universal can be set to the respective pipe inside diameter. Furthermore, the unit, the gas type and the reference condition can be set. The meter reading can be set to „zero“ if necessary.

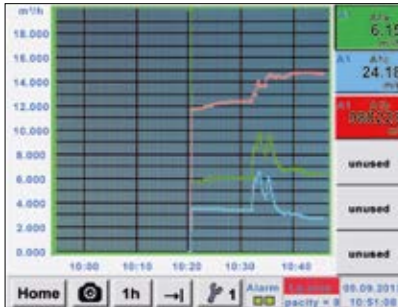

Graphic view

In the graphic view all measured values are indicated as curves. It is possible to browse back on the time axis by a slide of the finger (without data logger maximum 24 h, with data logger back to the start of the measurement).



Data logger

With the option „integrated data logger“ the measured values are stored in the Check Box M6/ Check Box M1-M5. The time interval can be free be determined. It is also possible to set the start time and end time of the data recording. Reading the measured data via USB interface or via the optional Ethernet interface.

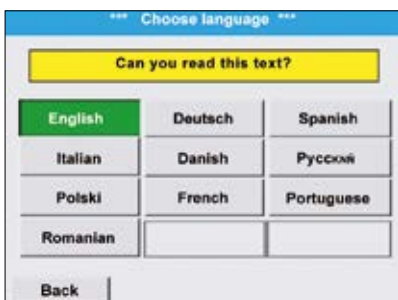

Selection of the language

Many languages are already stored in every Check Box M6 mobile/ Check Box M1-M5. The desired language can be selected via the selection button.

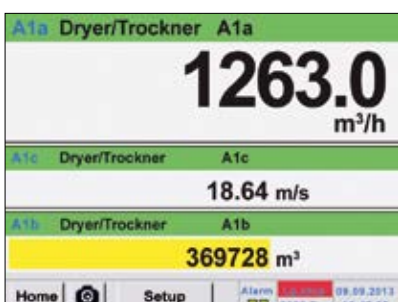

All relevant parameters at a glance

In addition to the flow rate in m³/h, the Check Box M6/ Check Box M1-M5 also displays other parameters such as total consumption in m³ and speed in m/s.









Technical Data of Check Box M1-M5

TECHNICAL DATA Check Box M1-M5	
Dimensions:	270 x 225 x 156 mm (W x H x D)
Weight:	2.2 kg
Inputs:	2 x 2 sensor inputs for digital or analogue sensor signals
Interface:	USB (standard), Ethernet (optional)
Power supply:	Internal rechargeable Li-Ion batteries, approx 8 h continuous operation, 4 h charging time
Options:	
Integrated data logger:	100 million measuring values start/stop time, measuring rate freely adjustable
2 additional sensor inputs:	for connection of pressure sensors, temperature sensors, clamp-on ammeters, third-party sensors with 4...20 mA 0 to 10 V, Pt100, Pt1000

INPUT SIGNALS	
Current signals internal or external power supply	(0...20mA/4...20mA)
Measuring range	0...20 mA
Resolution	0.0001 mA
Accuracy	± 0.03 mA ± 0.05 %
Input resistance	50 Ω
Voltage signal: Measuring range	(0...1 V) 0...1 V
Resolution	0.05 mV
Accuracy	± 0.2 mV ± 0.05 %
Input resistance	100 kΩ
Voltage signal Measuring range	(0...10 V / 30 V) 0...10 V
Resolution	0.5 mV
Accuracy	± 2 mV ± 0.05 %
Input resistance	1 MΩ
RTD Pt 100 Measuring range	-200...850°C
Resolution	0.1°C
Accuracy	± 0.2°C (-100...400°C) ± 0.3°C (further range)
RTD Pt 1000 Measuring range	-200...850°C
Resolution	0.1°C
Accuracy	± 0.2° (-100...400°C)
Impuls Measuring range	Min pulse length 500 µs frequency 0...1 kHz max. 30 VDC

DESCRIPTION	ORDER-NO.		
Check Box M1-M5 chart recorder with graphic display touch screen and integrated data logger	M1 Digital	-----	2255330402
	M2 Digital	Digital	2255330403
	M3 Digital	Analog	2255330404
	M4 Analog	-----	2255330405
	M5 Analog	Analog	2255330406
Option:			
Option: Integrated Ethernet and RS 485 interface	2255460216		
Option: Integrated webserver	2255460218		
Option: „Mathematics calculation function“ for 4 freely selectable channels, (virtual channels): addition, subtraction, division, multiplication	2255332469		
Option: „Totalizer function for analogue signals“	2255332470		
Further accessories:			
PMH Basic – data evaluation graphically and in tabular form - reading of the measured data via USB or Ethernet, license for 2 workstations	2255332468		
PMH Soft Energy Analyzer for energy and leakage analysis of compressed air stations	2255331729		
Connecting cable for pressure, temperature and external sensors to mobile devices, ODU/open ends, 5 m	2255332514		
Connecting cable for pressure, temperature and external sensors to mobile devices, ODU/open ends, 10 m	2255332515		
Connection cable for Flow/ PDP sensors to mobile devices, ODU/M12, 5m	2255332516		
Extension cable for mobile devices, ODU/ODU, 10 m	2255332517		
Connecting cable for mobile current / active power meter to mobile devices, length 5 m	2255332519		
Case for all sensors (dimensions: 500x360x120 mm)	2255332518		

Digital	Digital	Digital	Digital
m³/h, m³	°Ctd	A, kW/h	
			
Flow sensor	Dew point sensor	Current meter	Third-party with RS 485

Analog	Analog	Analog	Analog
bar	A	°C	°C
			4...20 mA 0...20 mA 0...10 V Pulse Pt 100 Pt 1000
Pressure sensor	Clamp-on ammeter	Temperature sensor	Third-party sensor analog output

Suitable sensors can be found on pages 30 to 33



Check Box 500 mobile - Hand-held instrument for industry

The new Check Box 500 mobile is an all-purpose hand-held measuring instrument for many applications in industry like e. g.:

- **Flow measurement**
- **Pressure/vacuum measurement**
- **Temperature measurement**
- **Moisture/dew point measurement**

The graphic indication of colored measurement curves is inimitably.

Up to 100 million measured values can be stored with date and name of measuring site. The measured values can be transferred to the computer by means of a USB stick. The data can be comfortably evaluated with the PMH Basic software.

Measured data and service reports can be issued easily and quickly. The following sensors can be connected to the freely configurable sensor input of Check Box 500 mobile:

- Pressure sensors (high and low pressure)
- Flow sensors, Flow Check/ Flow Check Universal
- Temperature sensors Pt 100, Pt 1000 / 4...20 mA
- Dew point sensors PDP Sens
- Effective power meters
- Optional third-party sensors with the following signals: 0...1/10 V, 0/4...20 mA, Pt 100, Pt 1000, pulse, Modbus



Special features:

- Universal sensor input for lots of common sensor signals
- Internal rechargeable Li-Ion batteries (approx. 12h continuous operation)
- 3.5" graphic display / easy operation via touch screen
- Integrated data logger for storage of the measured values
- USB interface for reading out via USB stick
- International: Up to 8 languages selectable

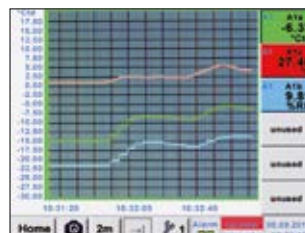

Measurement curves are indicated graphically and thus the user can see the behavior of the dryer at a glance since the start of the measurement.

DewPoint	
-46.3 °Ctd	
WT	TD
8.18 ppm	44.88 mg/m ³
Ttc	C1a Pressure C1a
25.01 °C	6.540 bar

All physical parameters of moisture measurement are calculated automatically. The measured values of the external sensor will be displayed in addition.

Logger settings	
1	Time interval (sec)
2	5 10 15 30 60 120 15
<input checked="" type="checkbox"/>	force new record file
Comment: <input type="text" value="Dryer Trockener 13"/>	
<input checked="" type="checkbox"/>	Logger stopped
<input checked="" type="checkbox"/>	timed Start
<input checked="" type="checkbox"/>	timed Stop
START	STOP
12:28:00 - 06.0	13:28:00 - 06.0
Remaining logger capacity = 9995 days	
Logging: 8 channels selected	
Time interval (min): 1 sec	
Back	

It is possible to store up to 100 million measured values. Each measurement can be stored with a comment, e.g. measuring site name. The time interval can be freely determined.

Check Box 500 mobile - Hand-held instrument with large sensor selection

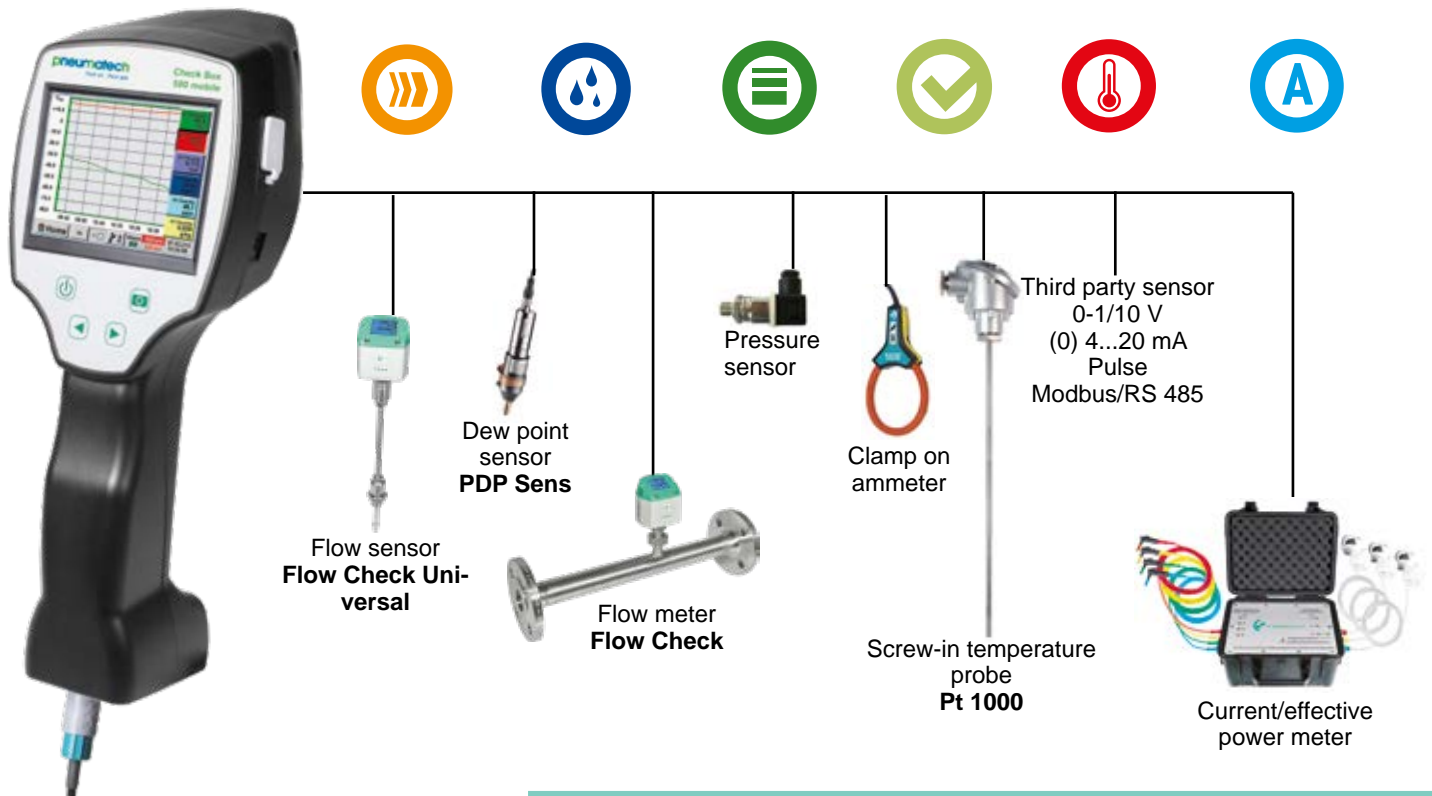

INPUT SIGNALS	
Current signals internal or external power supply	(0...20mA/4...20mA)
Measuring range	0...20 mA
Resolution	0.0001 mA
Accuracy	$\pm 0.03 \text{ mA} \pm 0.05 \%$
Input resistance	50 Ω
Voltage signal:	(0...1 V)
Measuring range	0...1 V
Resolution	0.05 mV
Accuracy	$\pm 0.2 \text{ mV} \pm 0.05 \%$
Input resistance	100 k Ω
Voltage signal	(0...10 V / 30 V)
Measuring range	0...10 V
Resolution	0.5 mV
Accuracy	$\pm 2 \text{ mV} \pm 0.05 \%$
Input resistance	1 M Ω
RTD Pt 100	
Measuring range	-200...850°C
Resolution	0.1°C
Accuracy	$\pm 0.2^\circ\text{C}$ (-100...400°C) $\pm 0.3^\circ\text{C}$ (further range)
RTD Pt 1000	
Measuring range	-200...850°C
Resolution	0.1°C
Accuracy	$\pm 0.2^\circ$ (-100...400°C)
Impuls	
Measuring range	Min pulse length 500 μs frequency 0...1 kHz max. 30 VDC

DESCRIPTION	ORDER-NO.
Check Box 500 mobile portable measuring instrument with integrated data logger, incl. power supply	2255332520
Option for Check Box 500 mobile: "mathematiPMH calculation function" for 4 freely selectable „virtual“ channels	2255332521
Option „Totalizer function for analogue signals“	2255332522
PMH Basic – data evaluation graphically and in tabular form - reading of the measured data via USB or Ethernet, license for 2 workstations	2255332468
Transport case	2255332523

Further sensors can be found on pages 30 to 33

TECHNICAL DATA Check Box 500 mobile	
Display:	3.5" touchpanel TFT transmissive, graphics, curves, statistics
Interface:	USB interface
Power supply for sensors::	Output voltage: 24VDC $\pm 10\%$ Output current: 120 mA in continuous operation
Power supply:	Internal rechargeable Li-Ion batteries, charging time approx. 4 h, Check Box 500 mobile continuous operation > 4h depending on power consumption for ext. sensor
Power adapter:	100 - 240 VAC / 50 - 60 Hz, 12 VDC - 1A, safety class 2 only for use in dry rooms
Dimensions:	82 x 96 x 245 mm
Housing material:	PC/ABS
Weight:	450 g
Operating temperature:	0...50°C Ambient temperature
Storage temperature:	-20 bis +70°C
EMC:	DIN EN 61326
Sensor input:	For connection of pressure and temperature sensors, current clamps, external sensors with 4 ... 20 mA, 0-10V, Pt 100, Pt 1000, Modbus
Memory Size:	8 GB - Memory card standard



Suitable sensors for Check Box M6, Check Box M1-M5, Check Box 500 mobile, PDP Check Mplus, Leak Check Pro 2

Flow meters for installation and removal under pressure (insertion-type)



Flow Check Universal

CONSUMPTION METERS INSERTION-VERSION	ORDER-NO.
Flow Check Universal flow meter, Max version (185 m/s), probe length 220 mm, incl. 5 m connection cable to mobile devices	2255332524
Flow Check Universal flow meter, High-Speed version (224 m/s), probe length 220 mm, incl. 5 m connection cable to mobile devices	2255332525

Inline flow meter

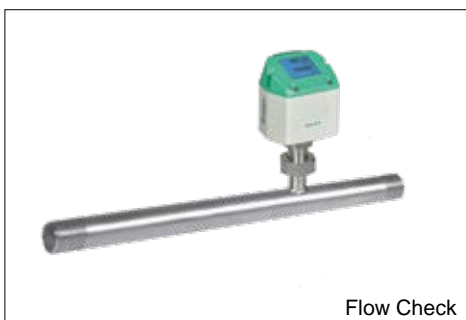

Flow Check

FLOW METERS INLINE VERSION	ORDER-NO.
Flow Check 1 with integrated measuring section, (R 1/4" DN 8)	2255330393
Flow Check 2 with integrated measuring section, (R 1/2" DN 15)	2255330394
Flow Check 3 with integrated measuring section, (R 3/4" DN 20)	2255330395
Flow Check 4 with integrated measuring section, (R 1" DN 25)	2255330396
Flow Check 5 with integrated measuring section, (R 1 1/4" DN 32)	2255330397
Flow Check 6 with integrated measuring section, (R 1 1/2" DN 40)	2255330398
Flow Check 7 with integrated measuring section, (R 2" DN 50)	2255330399



PDP Sens

DEW POINT SENSORS	ORDER-NO.
PDP Sens 2 set dew point sensor, -80 ... + 20 ° Ctd incl. measuring chamber mobile and 5 m connection cable to mobile devices	2255332526
PDP Sens 1 set dew point sensor, -20 ... + 50 ° Ctd incl. measuring chamber mobile and 5 m connection cable to mobile devices	2255332527

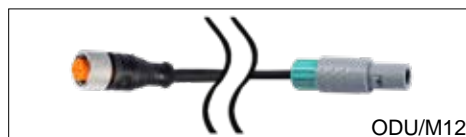

ODU/M12

CONNECTION CABLE FOR FLOW CHECK UNIVERSAL/ FLOW CHECK AND PDP SENS 1/2 SENSORS	ORDER-NO.
Connection cable for Flow/ PDP sensors to mobile devices, ODU/M12, 5 m	2255332516
Extension cable for mobile für mobile equipment, 10 m	2255332517

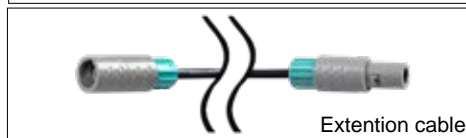

Extention cable



Suitable sensors for Check Box M6, Check Box M1-M5, Check Box 500 mobile, PDP Check Mplus, Leak Check Pro 2



PRESSURE PROBES	± 1% ACCURACY	± 0,5% ACCURACY
Standard pressure probe PMH 16, 0...16 bar	2255330414	2255332478
Standard pressure probe PMH 40, 0...40 bar	2255330415	2255332479
Standard pressure probe PMH 1.6, 0. 1.6 bar abs.		2255332480
Standard pressure probe PMH 10, 0...10 bar	2255332477	2255332481
Standard pressure probe PMH 100, 0...100 bar		2255332482
Standard pressure probe PMH 250, 0...250 bar		2255332483
Standard pressure probe PMH 400, 0...400 bar		2255332484
Precision pressure probe PMH -1...+15 bar, ± 0.5% accuracy of. f.s.		2255332485
Differential pressure probe 1.6 bar diff.		2255332486
Calibration certificate pressure, 5 calibration points for the whole measuring range	2255332487	

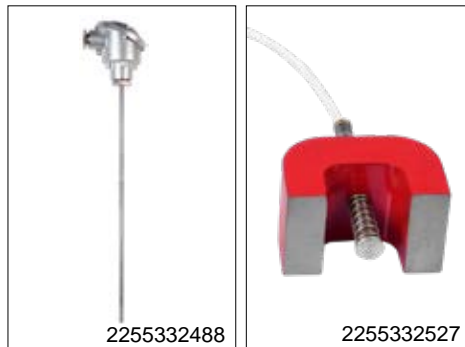

2255332488

2255332527

TEMPERATURE SENSORS	ORDER-NO.
Bendable temperature probe PT 100 (2-wire) class A, length: 300 mm, d=3 mm, -70°C to +500°C, connect cable PFA, 2 m with ODU-plug (8 pole) to mobile instruments	2255332526
Screw-in temperature sensor PT 100 class A, length 300 mm, d = 6 mm, with transmitter 4...20 mA = -50 °C...+ 500 °C (2-wire)	2255332488
Cross-band surface temperature probe, thermocouple Type K, with integrated transducer 4...20 mA = 0°C...+180°C, 2 m connect calbe (PVC) with ODU-plug (8-pole) to mobile instruments	2255332527
Cable temperature sensor PT 100 class A (4-wire), length: 300 mm, d = 6 mm, -70 ... + 260 ° C, 5 m connect cable PFA with open ends	2255332491
Cable temperature sensor PT 100 class A (4-wire), length: 100 mm, d = 6 mm, -70 ... + 260 ° C, 5 m connection cable PFA with open ends	2255332492
Cable temperature sensor PT 100 class A (4-wire), length: 200 mm, d = 6 mm, -70 ... + 260 ° C, 5 m connect cable PFA with open ends	2255332493
Magnetic surface temperature sensor, magnet 39x26x25 mm, PT 100 class B (2-wire), -30...+ 180 ° C, 5m connection cable PFA with open ends	2255332494
Compression fittings: 6mm; G 1/2" teflon clamping ring pressure-tight up to 10 bar. Material: stainless steel, application area: max. + 260 °C	2255332495
Compression fittings: 6mm; G 1/2" teflon clamping ring pressure-tight up to 16 bar. Material: stainless steel, application area: max. + 260 °C	2255332496
Calibration certificate temperature, 2 calibration points	2255332497



2255332491



2255332526

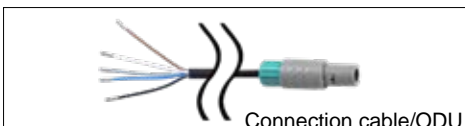

Connection cable/ODU

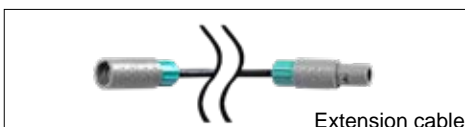

Extension cable



ODU connector

CONNECTION CABLES FOR PRESSURE SENSORS / TEMPERATURE SENSORS:	ORDER-NO.
Connection cable for pressure, temperature and external sensors to mobile devices, ODU/open ends, 5 m	2255332514
Connection cable for pressure, temperature and external sensors to mobile devices, ODU/open ends, 10 m	2255332515
Extension cable for mobile instruments, ODU / ODU, 10 m	2255332517
ODU plug for connection to mobile devices	2255332528



Clamp-on ammeter

CLAMP ON AMMETER	ORDER-NO.
Clamp-on ammeter 0 ... 1000 A TRMS incl. 3 m connection cable	2255332529
Clamp-on ammeter 0 ... 400 A TRMS incl. 3 m connection cable	2255332530



Suitable sensors for Check Box M6, Check Box M1-M5, Check Box 500 mobile



CURRENT/EFFECTIVE POWER METER	ORDER-NO.
PMH PM 600 mobile current/effective power meter up to 100 A	2255332531
PMH PM 600 mobile current/effective power meter up to 600 A	2255332532
<ul style="list-style-type: none"> - Mobile current effective power meter with 3 external current transformers for big machines and plants • External current transformers for clamping around the phases (100 A or 600 A) • External magnetic measuring tip for measuring the voltage • measures kW, kWh, cos, phi, kVar, kVA • Data transfer to Check Box M6 / Check Box M1-M5 via Modbus • Incl. connection cable for mobile current/effective power meter to mobile instruments, 5 m 	
Current transformer 100A/1A consisting of 3 transformers for mobile instruments	2255332533
Current transformer 600A/1A consisting of 3 transformers for mobile instruments	2255332534
Current transformer 1000A/1A consisting of 3 transformers for mobile instruments	2255332535

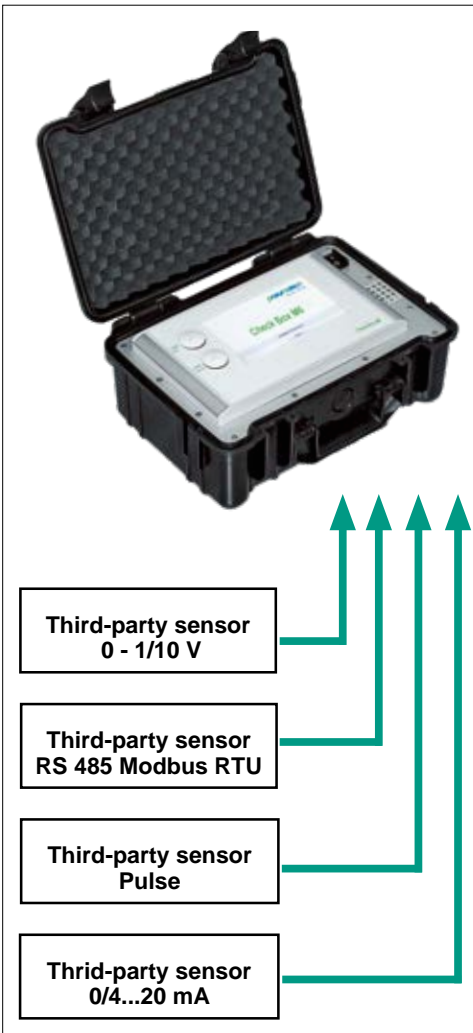

ANY THIRD-PARTY SENSOR CONNECTABLE
<p>Additionally, any third-party sensors with the following signal outputs can be connected:</p> <ul style="list-style-type: none"> • 4-20 mA • 0-20 mA • 0-1 V / 0-10 V / 0-30 V • Pt 100 (2- or 3-wire) • Pt 1000 (2- or 3-wire) • Pulse outputs (e. G. of gas gas meters) • Frequency output • Modbus protocol

PMH PM 600 -

Mobile current/effective power meter suitable for:

Check Box M6/ Check Box M1-M5/ Check Box 500 mobile

Measures voltage, current and calculates:

- Active power [kW]
- Apparent power [kVA]
- Reactive power [kVar]
- Active energy [kWh]
- cos phi

All measured data are transferred digitally (Modbus) to Check Box M6/ Check Box M1-M5 and can be recorded there.



Current transformer can be opened

Magnetic voltage measuring tips electrically isolated



Special features:

- Magnetic voltage measuring tips for measuring the voltage during operation
- Hinged current transformers encompass the conductors of the phases L1, L2, L3. This can also be done during operation



Example: Measurement at a compressor

TECHNICAL DATA PMH PM 600

Parameters:	Voltage (Volt) Current (Ampere) Cos phi Active power (kW) Apparent power (kVA) Reactive power (kVar) Active energy (kWh) Supply frequency (Hz) All parameters are transferred digital to Check Box M6/ Check Box M1-M5
Accuracy current measurement:	Threshold values for current deviation. Loss angle according to IEC 60044-1. Current deviation in % at rated current in 120 % 1 100 % 1 20 % 1,5 5 % 3

Accuracy active energy:	IEC 62053-21 Class 1
--------------------------------	----------------------

Sensor connections:	3 x current transformers (L1,L2,L3,N) 4 x voltage measurement (L1,L2,L3,N)
----------------------------	---

Interface:	RS 485 (Modbus protocol)
-------------------	--------------------------

Measure range:	Voltage measurement max. 400 Volt Current measurement max. 100 A resp. 600 A
-----------------------	---

Size current transformers:	100 A / 1 A (max.24 mm wire) 600 A / 1 A (max. 36 mm wire)
-----------------------------------	---

Dimensions case:	270 x 225 x 156 mm (B x H x T)
-------------------------	--------------------------------

Operating temperature:	- 10...+40°C
-------------------------------	--------------

DESCRIPTION	ORDER-NO.
PMH PM 600 current/effective power meter up to 100 A	2255332531
PMH PM 600 current/effective power meter up to 600 A	2255332532
<ul style="list-style-type: none"> • Mobile current effective power meter with 3 external current transformers for big machines and plants • External current transformers for clamping around the phases (100 A or 600 A) • External magnetic measuring tip for measuring the voltage • Misst kW, kWh, cos, phi, kVar, kVA • Data transfer via Modbus • Incl. connection cable for mobile current/effective power meter to mobile instruments, 5 m 	
Current transformer 100A/1A consisting of 3 transformers for mobile instruments	2255332533
Current transformer 600A/1A consisting of 3 transformers for mobile instruments	2255332534
Current transformer 1000A/1A consisting of 3 transformers for mobile instruments	2255332535



PDP Check M/ PDP Check M plus - Mobile dew point meters with data logger

Applications:

- Compressed air: Examination of refrigeration, membrane, adsorption dryers
- Technical gases: Residual moisture measurement in gases such as N₂, O₂ etc.
- Plastic industry: Examination of granulate dryers

Special features:

- Precise dew point measurement down to -80°Ctd
- Quick response time
- 3.5" graphic display / easy operation via touch screen
- Integrated data logger for storage of the measured values
- USB interface for reading out via USB stick
- Calculates all necessary moisture parameters like g/m³, mg/m³, ppm V/V, g/kg, °Ctdatm
- 2nd freely assignable sensor input for third-party sensors (only DP 510)
- International: Up to 8 languages selectable



Quick installation by means of measuring chamber and quick connector



Ideal for service technicians - everything in one case



Dry container - for sensor protection and quick adaptation time

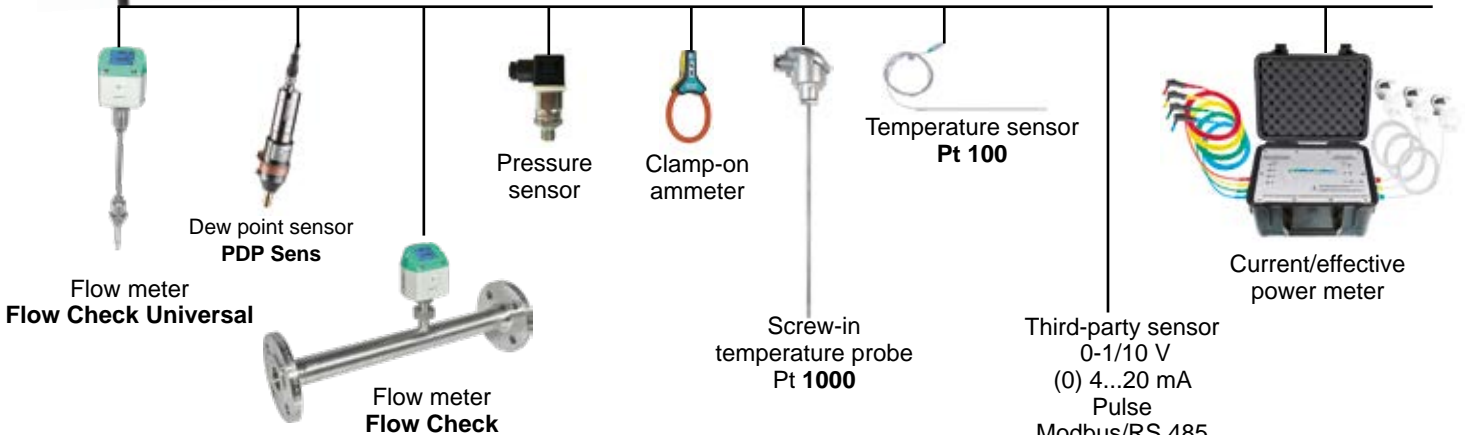

The whole range of suitable sensors can be found on pages 30 to 33

Everything a glance

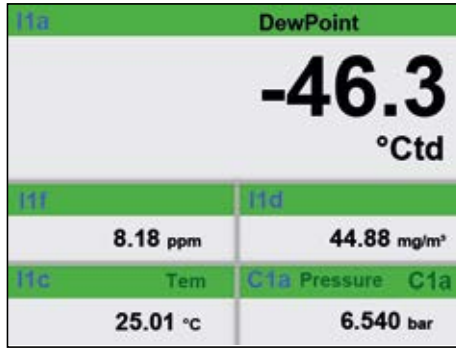
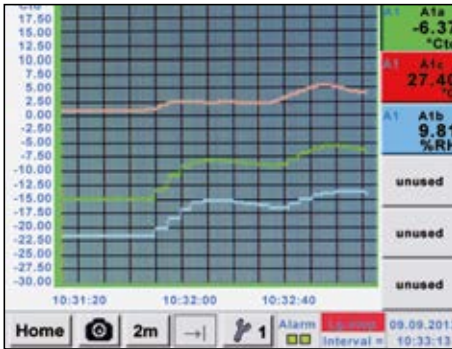

Gradients are displayed graphically, so the operator sees at a glance the behavior of the dryer since the start of the measurement.

All physical parameters of the humidity measurement are calculated automatically. The PDP Check M plus also displays the measured values of the external sensor.

Up to 100 million readings can be stored. Each measurement may be accompanied by a comment, e. g. location name. The time interval can be determined freely.

DESCRIPTION	ORDER-NO.
PDP Check M in a case - consisting of:	2255330386
- Portable dew point meter PDP Check M for compressed air and gases	2255332534
- Mobile measuring chamber up to 16 bar	2255332535
- Diffusion-tight PTFE hose with quick connector, length 1 m	2255332536
- Power supply for PDP Check M/ PDP Check M plus	2255332537
- Control and calibration set 11.3 % RH	2255332538
- Quick-lock coupling	2255332539
- Dry container for PMH dew point sensors	2255332540
- Transportation case (small) for PDP Check M	2255332541
PDP Check M plus in a case - consisting of:	2255332453
- Mobile dew point meter PDP Check M plus with one additional input external sensors	2255332541
- Mobile measuring chamber up to 16 bar	2255332535
- Diffusion-tight PTFE hose with quick connector, length 1 m	2255332536
- Power supply for PDP Check M/ PDP Check M plus	2255332537
- Control and calibration set 11.3 % RH	2255332538
- Quick-lock coupling	2255332539
- Dry container for PMH dew point sensors	2255332540
- Transportation case (large) for PDP Check M plus as well as other sensors	2255332523
Further options, not included in the set:	
Option: „Mathematics calculation function“ for 4 freely selectable channels, (virtual channels): addition, subtraction, division, multiplication	2255332521
Option: „Totalizer function for analogue signals“	2255332522
PMH Basic – data evaluation graphically and in tabular form - reading of the measured data via USB or Ethernet, license for 2 workstations	2255332468
Precision calibration at -40°Ctd or 3°Ctd with ISO certificate	2255332542
Additional calibration point freely selectable in the range between -80...+20°Ctd	2255332543
High pressure measuring chamber up to 350 bar	2255332544
Measuring chamber for atmospheric dew point	2255332545
Measuring chamber for granulate driers with minimum overpressure	2255332546
Portable dew point meter PDP Check M plus for compressed air and gases (high pressure version up to 350 bar)	2255332547
Portable dew point meter PDP Check M for compressed air and gases (high pressure version up to 350 bar)	2255332548



Photo key saves current screen as an image file. No additional software necessary.

TECHNICAL DATA PDP Check M/ PDP Check M plus	
Display:	3.5" Touch screen
Measuring range:	-80...+50°Ctd -20...+70°C 0...100 %rF
Accuracy:	± 0,5°Ctd bei -10...+50°Ctd Typ. ± 2°Ctd (remain. range)
Moisture parameters:	g/m ³ , mg/m ³ , ppm V/V, g/kg, °Ctdatm, %rF
Pressure range:	-1...50 bar standard -1...350 bar special version
Interface:	USB interface
Data logger:	8 GB SD memory card (100 millions values)
Power supply for sensors:	Output voltage: 24 VDC ± 10% Output current: 120 mA continuous operation
Power supply:	Internal rechargeable Li-Ion batteries, approx 12 h continuous operation, 4 h charging time
Screw-in thread:	G 1/2" stainless steel
Ambient temperature:	0...+50°C
EMV:	DIN EN 61326-1



PDP Sens 1/ PDP Sens 1A/ PDP Sens 2/ PDP Sens 2A - Dew point sensor

for residual moisture measurement in compressed air and gases



Typical applications:

- Dew point measurement in the compressed air after adsorption dryer, membrane dryer, refrigeration dryer
- Residual moisture/ dew point measurement in gases like oxygen, nitrogen, argon ...
- Residual moisture/ dew point measurement after granulate dryers in plastiPMH industry

Recommendation:

Mounting with standard measuring chamber for compressed air up to 16 bar

Advantage: Easy installation via quick coupling

Special features:

- Extremely long-term stable
- Analog output 4 ... 20 mA for dew point
- Condensation insensitive
- Fast adjustment time
- Pressure resistant up to 350 bar (special version)
- **NEW:** Modbus RTU interface
- **NEW:** Higher resolution of the sensor signal due to improved evaluation electronics
- **NEW:** Sensor diagnosis on site with mobile device or PMH service software
- Readable via Modbus:
 - Pressure dew point [° Ctd.]
 - Temperature [° C]
 - Rel. humidity [% RH]
 - Abs. humidity [g / m³]
 - Moisture content [g / m³]
 - Moisture content V / V [ppmV / V]
 - Partial vapor pressure [hPa]
 - Atmospheric dew point [° Ctd.atm]

DESCRIPTION	ORDER-NO.
PDP Sens 2 dew point sensor for desiccant driers -80°...20°Ctd incl. inspection certificate, 4...20 mA output signal (3-wire connection) and Modbus-RTU interface	2255330413
PDP Sens 2A dew point sensor for desiccant driers -80°...20°Ctd incl. inspection certificate, 4...20 mA output signal (2-wire connection) or Modbus-RTU interface	2255331723
PDP Sens 1 dew point sensor for refrigerated driers -20...50°Ctd incl. inspection certificate, 4...20 mA output signal (3-wire connection) and Modbus-RTU interface	2255330412
PDP Sens 1A dew point sensor for refrigerated driers -20...50°Ctd incl. inspection certificate, 4...20 mA output signal (2-wire connection) and Modbus-RTU interface	2255332552
Connection cables:	
Connection cable for Flow/ PDP sensors, 5 m	2255460213
Connection cable for Flow/ PDP sensors, 10 m	2255460214
Option for PDP Sens 1/ PDP Sens 2:	
Option: analogue output PDP Sens 1/2, Special version 2...10 Volt	2255332553
Option for: PDP Sens 1/ PDP Sens 1A/ PDP Sens 2/ PDP Sens 2A	
Option: max. pressure PDP sens 350 bar	2255332591
Option: special scaling PDP sens 4...20 mA= __ ... __ g/m³, ppm etc.	2255332592
Option: connection thread PDP sens, 5/8" UNF	2255332593
Option: connection thread PDP sens, 1/2" NPT	2255332594
Option: surface condition PDP sens, free of oil & grease	2255332595
Further accessories:	
Standard measuring chamber up to 16 bar	2255460229
High pressure measuring chamber up to 350 bar	2255332544
Measuring chamber, stainless steel 1.4305	2255332596
PMH Service Software for dew point sensors incl. PC connection set (Modbus to USB Interface)	2255332597
Calibration and adjustment:	
Precision calibration at -40°Ctd or 3° Ctd including ISO certificate	2255332542
Additional calibration point freely selectable	2255332543

TECHNICAL DATA PDP Sens 1/ PDP Sens 1A/ PDP Sens 2/ PDP Sens 2A	
Measure range:	-80...20°Ctd, -20...50°Ctd
Accuracy:	± 1°C to 50...-20°Ctd ± 2°C to -20...-50°Ctd ± 3°C to -50...-80°Ctd
Pressure range:	-1...50 bar special version up to 350 bar
Power supply:	24 VDC (16...30 VDC)
Protection class:	IP 65
EMV:	according to DIN EN 61326-1
Operating temp.:	-20...70 °C
Connection:	M12, 5-pole
PC connection	Modbus-RTU interface (RS 485)
Analog output	4...20 mA = -80...20°Ctd 4...20 mA = -20...50°Ctd PDP Sens 1/2: 4...20 mA (3-wire) PDP Sens 2A : 4...20 mA (2-wire)
Burden for analog output:	< 500 Ω
Screw-in thread:	G 1/2" optional: UNF 5/8", NPT 1/2"
Dimensions:	Ø 30 mm, length approx. 130 mm
Via service software:	
Choose units	% RH, °Ctd, g/m³, mg/m³, ppm V/V
Scaling	change 4...20 mA

PDP Check S - Dew point monitoring

The dew-point set is wired ready to plug in at the factory. The alarm values can be set freely. The dew point sensor PDP Sens 1/2 is extremely long-term stable and can be quickly and easily installed and removed under pressure via the screw-on measuring chamber incl. Quick coupling.

Option:
Alarm unit
(Buzzer and continuous red light)

Consisting of:
Digital process meter PDP Check S

Special features:

- System ready for plug-in: Everything completely wired
- No time-consuming studying of the instruction manual
- 2 alarm contacts (230 VAC, 3 A) pre- and main alarm freely adjustable
- 4...20 mA analogue output
- Option alarm unit: Buzzer and continuous red light



DESCRIPTION	ORDER-NO.
Dew point monitoring PDP Check S2 for desiccant driers consisting of:	2255330390
PDP Check S LED display in wall housing	2255332549
PDP Sens 2 dew point sensor for desiccant driers -80°...20°Ctd incl. inspection certificate, 4...20 mA output signal (3-wire connection) and Modbus-RTU interface	2255330413
Standard measuring chamber up to 16 bar	2255460229
Connection cable for Flow/ PDP sensors, 5 m	2255460213
Dew point monitoring PDP Check S for refrigeration dryers, consisting of:	2255330387
PDP Check S LED display in wall housing	2255332549
PDP Sens 1/2 dew point sensor for refrigeration dryer -20...50°Ctd incl. inspection certificate, 4...20 mA output signal (3-wire connection) and Modbus-RTU interface	2255330412
Standard measuring chamber up to 16 bar	2255460229
Connection cable for Flow/ PDP sensors, 5 m	2255460213
Options:	
Power supply 24 VDC (instead of 230 VAC)	2255330388
Power supply 110 VAC (instead of 230 VAC)	2255330389
Alarm unit mounted at wall housing	2255460211
Alarm unit for external mounting with 5 m cable	2255460231
Calibration and adjustment:	
Precision calibration at -40°Ctd including ISO certificate	2255332542
Additional calibration point freely selectable	2255332543

TECHNICAL DATA DISPLAY PDP Check S	
Dimension:	118 x 92 x 93 mm
Display:	LED red, 7 segments, height: 13 mm, 5 digits, 2 LED for alarm relay
Keypad:	4 keys
Input:	4...20 mA
Power supply:	230 VAC, 50/60 Hz; Option: 24 VDC or 110 VAC 50/60 Hz
Alarm outputs:	2 x relay output, changeover contact, 250 VAC, max. 3 A
Operating temperature:	-10...+60 °C (storage temperature -20°C...+80°C)
Alarm thresholds:	freely adjustable
Hysteresis:	2 °Ctd
Analog output:	4...20 mA = -80...20 Ctd or -20...50°Ctd.



PDP Check S3/S4 Dew point monitoring

For stationary dew point monitoring of refrigeration or desiccant dryers. The touch screen graphic display enables an intuitive operation and shows the progress of the measured values. 2 alarm relays are available for monitoring of threshold values. Available either with a classic analogue output 4...20 mA or optionally with digital interfaces like Ethernet and RS 485 (Modbus protocol). As a stand-alone solution the measured data stored in the optional data logger can be read-out via USB stick and evaluated by means of the software PMH Soft Basic.

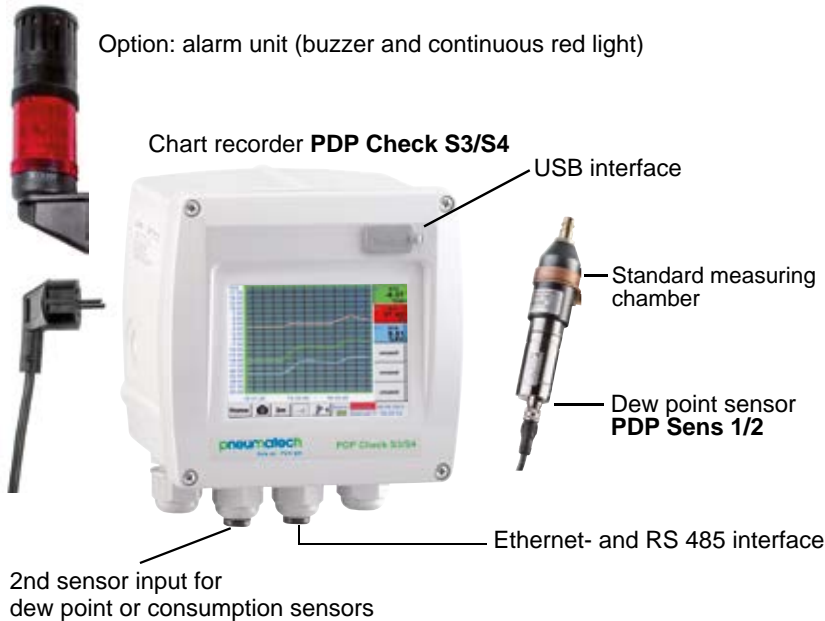

Special features:

- 3.5" Graphic display – easy to use with touch-screen
- Plug-in system: everything wired and ready
- 2 alarm contacts (230 VAC, 3 A) Pre-alarm and main alarm freely adjustable
- An alarm delay can be set for each alarm relay
- 4...20 mA Analog output
- Option: Ethernet and RS 485 interface (Modbus protocols)
- Option: Webserver

Transfer the data via USB stick to the PC



- **Option:** Integrated data logger
- Record dew point curve up to 100 million readings
- PMH Basic for graphical and tabular evaluation. Read out data either via USB stick or Ethernet

DESCRIPTION	ORDER-NO.
Dew point monitoring PDP Check S3 for desiccant driers (-80...+20° Ctd.)	2255332598
Dew point monitoring PDP Check S4 for refrigeration driers (-20...+50°Ctd)	2255332599
Options	
Option: Integrated data logger for 100 million measured values	2255460217
Option: Integrated Ethernet and RS 485 interface	2255460216
Option: Integrated webserver	2255460218
Option: 2 additional sensor inputs for analogue sensors (pressure sensor, temperature sensor and so on)	2255332600
Additional accessories	
PMH Basic – data evaluation graphically and in tabular form - reading of the measured data via USB or Ethernet, license for 2 workstations	2255332468
Alarm unit mounted at wall housing	2255460211
Alarm unit for external mounting with 5 m cable	2255460231
Calibration and adjustment	
Precision calibration at -40 °Ctd or +3 °Ctd including ISO certificate	2255332542

TECHNICAL DATA PDP Check S3/ S4	
Dimensions:	118 x 115 x 98 mm IP 54 (wall housing) 92 x 92 x 75 mm (panel mounting)
Inputs:	2 digital inputs for PDP Sens 1/2 resp. Flow Check
Interface:	USB interface
Power supply:	100...240 VAC, 50-60 Hz
Accuracy:	please see PDP Sens 1/2
Alarm outputs:	2 relays, (pot. - free)
Options	
Data logger:	100 million measuring values start/stop time, measuring rate freely adjustable
2 additional sensor inputs:	for connection of pressure sensors, temperature sensors, clamp-on ammeters, third-party sensors with 4...20 mA 0 to 10 V, Pt 100, Pt 1000

TECHNICAL DATA PDP Sens 1/2	
Measuring range:	-80...20 °Ctd resp. -20...50 °Ctd
Accuracy:	± 1 °C at 50...-20 °Ctd ± 2 °C at -20...-50 °Ctd ± 3 °C at -50...-80 °Ctd
Pressure range:	-1...50 bar, special version up to 350 bar

Easy operation via Touch screen

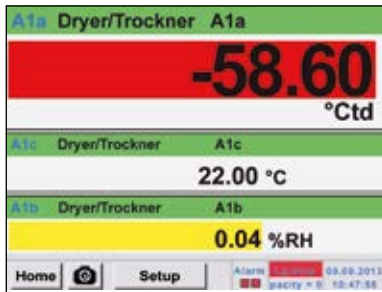

Actual measured values

All measured values can be seen at a glance. Threshold exceeding are indicated in red color. A „measuring site name“ can be allocated to each sensor.

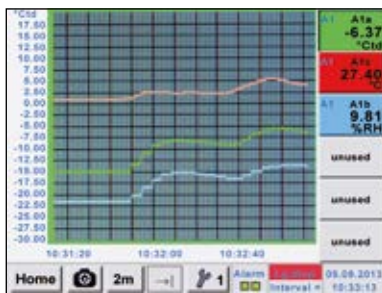

Graphic view

In the graphic view all measured values are indicated as curves. It is possible to brows back on the time axis by a slide of the finger (without data logger maximum 24 h, with data logger back to the start of the measurement).

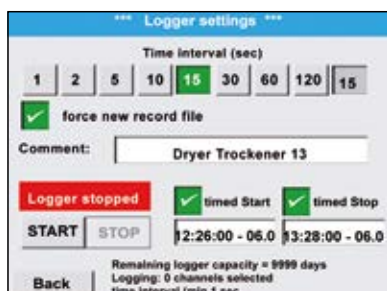

Data logger

Measured values are stored in Check Box S by means of the option „integrated data logger“. The time interval can be freely set. Furthermore there is the possibility to fix the starting time and the end time of the data recording. Read-out of the measured data via USB interface or via the optional Ethernet interface.

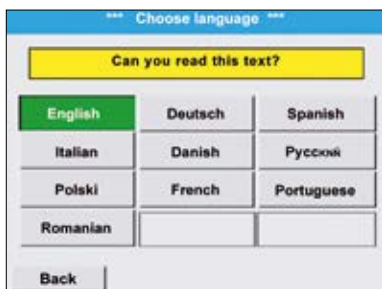

Selection of the language

Check Box S „speaks“ several languages. The required language can be selected by means of the select button.

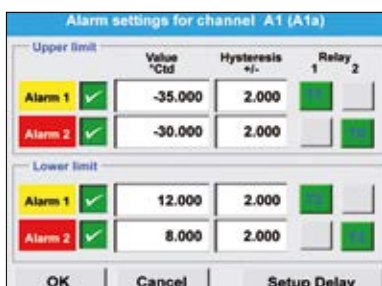

Adjustment of the alarm relays

Each one of the 2 alarm relays can be allocated individually to a connected sensor. The alarm thresholds and the hysteresis can be freely adjusted.

New: It is possible to set an alarm delay for each alarm relay so that the relay is just triggered after that period of time.



Accessories for PDP Sens 1, 1A, 2, 2A



DESCRIPTION	ORDER-NO.
Diffusion-tight PTFE hose 6 mm with quick-release coupling length 1m	2255332536
Diffusion-tight PTFE hose 6 mm, length 1m	2255332602



DESCRIPTION	ORDER-NO.
Cooling section made of stainless steel	2255332603

- 8 mm stainless steel tube wound as a spiral.
- With the cooling section, process gases from ovens etc. can be cooled from high temperatures (about 900°C) to a sensor-compatible temperature of about 50°C. Condensation of the dew point to be avoided.

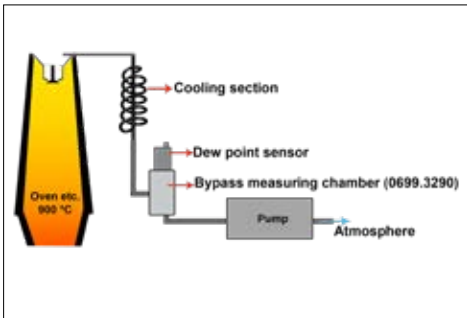

DESCRIPTION	ORDER-NO.
Quick-lock coupling NW 7,2 - G 1/2" male thread	2255332539



DESCRIPTION	ORDER-NO.
Control and calibration set 11,3 %RH	2255332538
Control and calibration set 33 %RH	2255332605
Control and calibration set 75,3 %RH	2255332606

- Control and calibration sets provide a defined humidity over a saturated saline solution
- The control and calibration set is screwed onto the dew point sensor and thus enables a simple and inexpensive control and calibration option down to -20° Ctd dew point on site

Accessories for PDP Sens 1, 1A, 2, 2A,



DESCRIPTION	ORDER-NO.
Dry container for PMH dew point sensors	2255332540

- Provides sensor protection and fast equalization time. Recommended for storage of mobile sensors

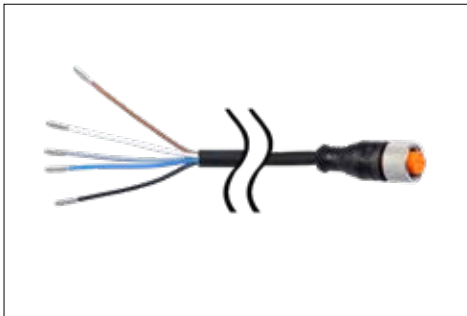

DESCRIPTION	ORDER-NO.
Connection cable for Flow / PDP series, 5 m	2255460213
Connection cable for Flow / PDP series, 10 m	2255460214
Connection cable for Flow / PDP series, 20 m	2255460215
Connection cable for Flow / PDP series, 5 m shielded	2255332607
Connection cable for Flow / PDP series, 10 m shielded	2255332608
Cable for alarm/pulse output, with M12 plug, 5 m	2255332609
Cable for alarm/pulse output, with M12 plug, 10 m	2255332610



DESCRIPTION	ORDER-NO.
M12 plug for PDP Sens 1, 1A, 2, 2A	2255332611
M12 plug angled 90°	2255332612



DESCRIPTION	ORDER-NO.
Adapter plug PDP Sens 1A/ 2A Michell easidew valve plug DIN 43650 shape C 8 mm	2255332613



DESCRIPTION	ORDER-NO.
Ethernet connection cable length 5 m, M12 plug x-coded (8 pol.) on RJ 45 plug	2255332614
Ethernet connection cable length 10 m, M12 plug x-coded (8 pol.) on RJ 45 plug	2255332615



Accessories for all PDP Sens



DESCRIPTION	ORDER-NO.
Mains unit in wall housing for max. 2 sensors of the Flow / PDP Sens series 100-240 V, 23 VA, 50-60 Hz / 24 VDC, 0,35 A	2255332616



DESCRIPTION	ORDER-NO.
Power supply unit 100-240 V AC/24 V for Flow / PDP Sens	2255332617

Measuring chambers



DESCRIPTION	ORDER-NO.
Standard measuring chamber for compressed air	2255460229

- Applicable for 2...16 bar
- Process connection: Plug nipple NW 7.2 (Parker series 26) or G1/4" female thread when used without plug nipple
- Sensor connection: G 1/2" female thread
- Gives 2-3 liters / min of process air to the environment
- The copper capillary relaxes the compressed air and prevents the backflow of moisture from the ambient air into the measuring chamber



DESCRIPTION	ORDER-NO.
Stainless steel measuring chamber for compressed air up to 50 bar	2255332618

- Applicable for 2...50 bar
- Process connection: G 1/4" female thread
- Sensor connection: G 1/2" female thread
- Gives 2-3 liters / min of process air to the environment



DESCRIPTION	ORDER-NO.
Stainless steel measuring chamber for compressed air up to 50 bar with NPT thread	2255332619

- Process connection: G 1/4" female thread
- Sensor connection: 5/8" UNF female thread
- Applicable for 2 ... 50 bar
- Gives 2-3 liters / min of process air to the environment via a fine nozzle



DESCRIPTION	ORDER-NO.
High pressure measuring chamber for compressed air up to 350 bar	2255332544

- Applicable for 30...350 bar
- Process connection: G 1/4" female thread
- Sensor connection: G 1/2" female thread
- Gives 2-3 liters / min of process air to the environment via a fine nozzle
- Via the high-pressure valve, the amount of air for sampling can be adjusted individually depending on the pressure level. The process air is released to the environment via the sinter filter



DESCRIPTION	ORDER-NO.
Stainless steel bypass measuring chamber for dew point measurement in gases under pressure	2255332596

- Applicable for -1...350 bar
- Process connection: G 1/4" female thread gas inlet and G 1/4" female thread gas outlet
- Sensor connection: G 1/2" female thread
- The flow of at least 2 liters / min of gas must be ensured by the customer



Measuring chambers



DESCRIPTION	ORDER-NO.
Measuring chamber for atmospheric dew point	2255332545

- Applicable for 2...16 bar
- Process connection: Plug nipple NW 7.2 (Parker series 26) or G 1/4" female thread when using without plug nipple
- Sensor connection: G 1/2" female thread
- Gives 2-3 liters / min of process air to the environment
- The throttle valve in front of the measuring chamber relaxes the compressed air to atmospheric pressure in the measuring chamber. The manometer integrated in the measuring chamber indicates the overpressure to the atmosphere



DESCRIPTION	ORDER-NO.
Measuring chamber for granulate dryers and gases	2255332546

- Applicable for -1...16 bar
- Process connection: Plug connection for 6 mm hose at inlet and outlet or G 1/4" female thread when using without plug connections
- Sensor connection G 1/2" female thread
- The flow of at least 2 liters / min of air / gas must be ensured by the customer



Calibration of dew point sensors

The calibration range for dew point sensors are $-80^{\circ}\text{Ctd} \dots 20^{\circ}\text{Ctd}$

Both dew point sensors from us and from other manufacturers can be calibrated. High precision reference measuring instruments with DKD resp. BAM certificate grant an accuracy of up to 0.1°C dew point..

Special feature:

Due to the digital data transmission, only the dew point sensor has to be calibrated. The display devices remain wired on site.



Calibration range: from -80 to 20°Ctd -
Accuracy of the DKD reference: $0,1^{\circ}\text{Ctd}$



Control and calibration set

Control and calibration sets guarantee a defined humidity by means of a saturated saline solution.

The control and calibration set is screwed onto the dew point sensor and therefore enables an easy and low-priced possibility for on-site control and calibration down to -20°C dew point.

DESCRIPTION	ORDER-NO.
Recalibration and precision calibration at -40°Ctd or 3°Ctd including ISO-Certifikate	2255332622
Precision calibration in the range $-80\dots 20^{\circ}\text{Ctd}$, $^{\circ}\text{Ctd}$ points freely selectable	2255332543
Control and calibration set 11.3 %RH	2255332538
Control and calibration set 33 %RH	2255332605
Control and calibration set 75.3 %RH	2255332606
Precision calibration at -40°Ctd or 3°Ctd including ISO certificate	2255332542
Replacement unit for the period of re-calibration	2255332625
Dew point sensor in exchange with calibration certificate at -40°Ctd	2255332626

PMH Service Software

With the PMH service software including the USB - Modbus interface adapter, the PDP Sens 1/ 1A/ 2/ 2A dew point sensors can be configured via laptop / PC. The following settings can be made via PMH Service Software:



- Scaling of the 4...20 mA analogue output
- Assignment of the measured variable to the analogue output (e.g. 4...20 mA = 0...10 g/m³)
- Available units: °Ctd, °Ftd, g/m³, mg/m³, ppmv/v, g/kg
- Reading out the firmware version, serial number, date of the last calibration
- One-point calibration (adjustment) of the sensors in the process. This requires a reference device
- Update of the sensor software (Firmware)
- Modbus settings as Modbus-ID, Baud rate, Stopbit, Parity

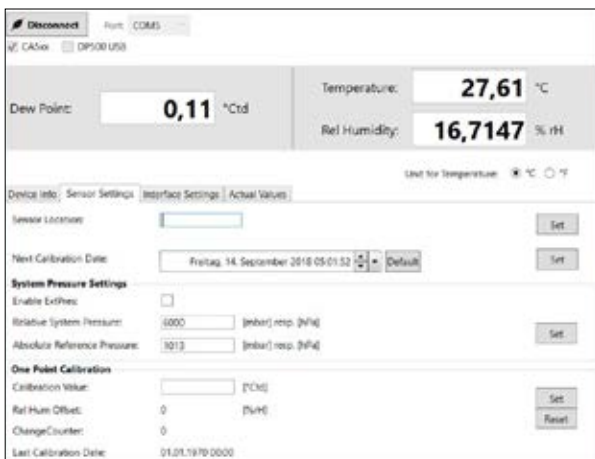
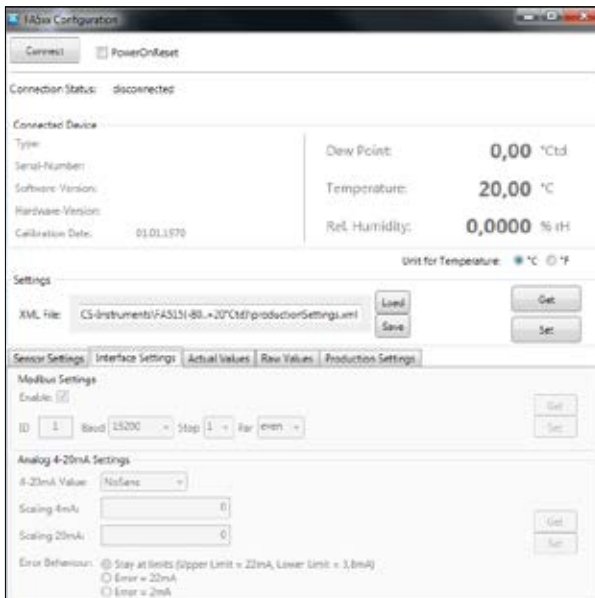

DESCRIPTION	ORDER-NO.
PMH Service Software incl. PC connection set, USB connection and interface adapter to the sensor	2255332597

Flow Check Universal - Flow meter for compressed air and gases



Special advantages:

- Incl. temperature measurement
- RS 485 interface, Modbus-RTU as a standard
- Integrated display for m³/h and m³
- Usable from 1/2" to DN 1000
- Easy installation under pressure
- 4...20 mA analog output for m³/h resp. m³/min
- Pulse output for m³ or M-Bus (optional)
- Inner diameter adjustable via keypad
- Total counter resettable
- Adjustable via keys at the display: Reference conditions, °C and mbar, 4...20 mA scaling, pulse weight



Inner diameter adjustable via keypad



Option:

Bi-directional measurement. Blue or green arrows in the display indicate the flow direction. A meter reading is available for each flow direction.



DESCRIPTION	ORDER-NO.
Flow Check Universal flow sensor in basic version: Standard (92.7 m/s), probe length 220 mm, without display	2255332455
Bi-directional measurement - includes 2 x 4 ... 20 mA analog outputs and 2x pulse outputs. These are not available for Ethernet (PoE) and M-Bus interface	2255332627
Options for Flow Check Universal :	
Display	2255332628
Max version (185 m/s)	2255332629
High Speed version (224 m/s)	2255332630
Low speed version (50 m/s)	2255332631
1 % Accuracy of m.v. ± 0,3 % of f.s.	2255332632
Ethernet-Interface for Flow Check/ Flow Check Universal	2255332633
Ethernet-Interface PoE for Flow Check/ Flow Check Universal	2255332634
M-Bus board for Flow Check/ Flow Check Universal	2255332635
Probe length 120 mm	2255332636
Probe length 160 mm	2255332637
Probe length 300 mm	2255332638
Probe length 400 mm	2255332639
Probe length 500 mm	2255332640
Probe length 600 mm	2255332641
ISO calibration certificate (5 calibration points) for Flow sensors	2255332642
Gas type: ____ (specify type of gas when ordering)	2255332643
Gas mixture: ____ (specify gas mixture when ordering)	2255332644
Real gas calibration	2255332645
Special cleaning oil and grease-free (e. g. oxygen application)	2255332646
Silicone-free version incl. cleaning free of oil and grease	2255332647
Additional calibration curve stored in the sensor (selectable via display)	2255332648
Certificate of origin	2255332649

TECHNICAL DATA Flow Check Universal	
Parameters:	m ³ /h, l/min (1000 mbar, 20 °C) in case of compressed air resp. Nm ³ /h, Nl/min (1013 mbar, 0 °C) in case of gases
Units adjustable via keys at display:	m ³ /h, m ³ /min, l/min, l/s, ft/min, cfm, m/s, kg/h, kg/min, g/s, lb/min, lb/h
Adjustable via keypad:	Diameter for volume flow calculation, counter resettable
Sensor:	Thermal mass flow sensor
Measuring medium	Air, gases
Gas types are adjustable over PMH service software or PMH data logger:	Air, nitrogen, argon, helium, CO ₂ , oxygen, vacuum
Measure range:	See table page 75
Accuracy: (m.v.: of meas. value) (f.s.: of full scale)	± 1.5 % of m.v. ± 0.3 % of f.s. on request ± 1.0 % of m.v. ± 0.3 % of f.s.
Operating temperature:	-30...110 °C probe tube -30...80 °C housing
Operating pressure:	-1...50 bar
Digital output:	RS 485 interface (Modbus-RTU), Optional: Ethernet-Interface PoE), M-Bus
Analog output:	4...20 mA for m ³ /h e. g. l/min;
Pulse output:	1 Pulse per m ³ or per liter galvanically isolated. Pulse value can be set on the display. Alternatively, the pulse output can be used as an alarm relay
Supply:	18...36 VDC, 5 W
Burden:	< 500 Ω
Housing:	Polycarbonate (IP 65)
Probe tube:	Stainless steel, 1.4301 Mounting length 220 mm, Ø 10 mm
Mounting thread:	G 1/2"
Ø Casing:	65 mm
Mounting position:	any

Further accessories see pages 54 to 58

Easy installation and removal under pressure

1) Even under pressure, the flow sensor Flow Check Universal is mounted by means of a standard 1/2" ball valve. During mounting and dismantling the circlip ring avoids an uncontrolled ejection of the probe which may be caused by the operating pressure.

For the mounting into different pipe diameters Flow Check Universal is available in the following probe lengths: 120, 160, 220, 300, 400 mm. So the flow sensors are being mounted into existing pipelines with inner diameters of 1/2" upwards.

The exact positioning of the sensor in the middle of the pipe is granted by means of the engraved depth scale. The maximum mounting depth corresponds with the respective probe length. Example: Flow Check Universal with probe length 220 mm has a maximum mounting depth of 220 mm.

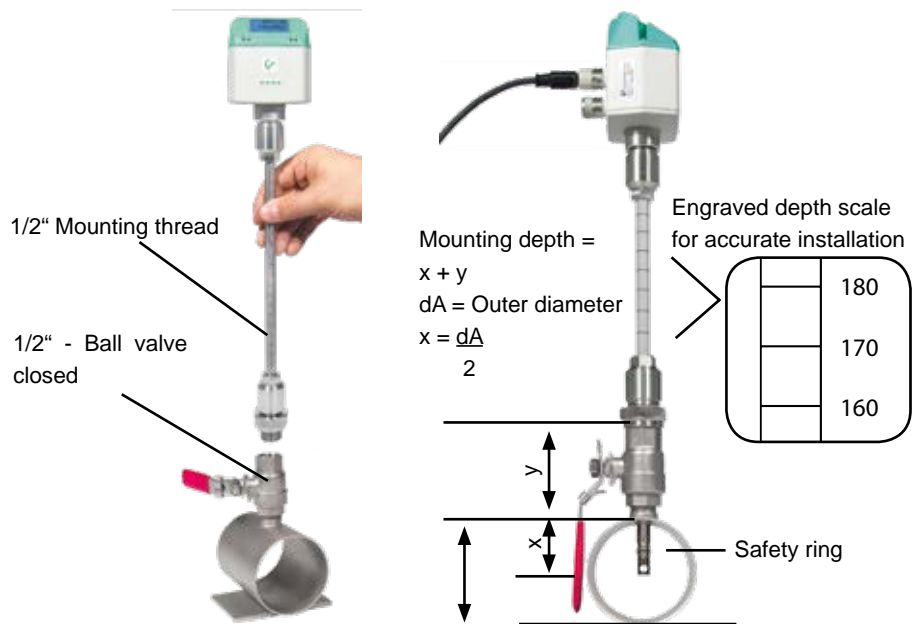

2) If there is no suitable measuring point with 1/2" ball valve, there are two easy ways to set up a measuring point:

- A** Weld on a 1/2" screw neck and screw on a 1/2" ball valve
- B** Mount spot drilling collar incl. ball valve (see accessories)

Drill holes can be drilled through the 1/2" ball valve into the existing tubing with the help of the drilling device, the drill chips are collected in a filter, then the probe is installed as described under 1).



A Screw neck



B Spot drilling collar



Drill under pressure with the PMH Drill

3) Due to the large measuring range of the probe even extreme requirements to the flow measurement (high volume flow in small pipe diameters) can be met.

The measuring range is depending on the pipe diameter - see table on the right hand side.

Measuring ranges Flow Flow Check Universal for compressed air (ISO 1217: 1000 mbar, 20°C)
Measuring ranges for other types of gas see pages 60 to 67

Inner diameter of pipe			Flow Check Universal Standard (92,7 m/s)		Flow Check Universal Max. (185,0 m/s)		Flow Check Universal High Speed (224,0 m/s)	
Inch	mm		Measuring range		Measuring range		Measuring range	
			m³/h	(cfm)	m³/h	(cfm)	m³/h	(cfm)
1/2"	16,1	DN 15	759 l/min	26	1516 l/min	53	1836 l/min	64
3/4"	21,7	DN 20	89 m³/h	52	177 m³/h	104	215 m³/h	126
1"	27,3	DN 25	148 m³/h	86	294 m³/h	173	356 m³/h	210
1 1/4"	36,0	DN 32	266 m³/h	156	531 m³/h	312	643 m³/h	378
1 1/2"	41,9	DN 40	366 m³/h	215	732 m³/h	430	886 m³/h	521
2"	53,1	DN 50	600 m³/h	353	1197 m³/h	704	1450 m³/h	853
2 1/2"	68,9	DN 65	1028 m³/h	604	2051 m³/h	1207	2484 m³/h	1461
3"	80,9	DN 80	1424 m³/h	838	2842 m³/h	1672	3441 m³/h	2025
4"	110,0	DN 100	2644 m³/h	1556	5278 m³/h	3106	6391 m³/h	3761
5"	133,7	DN 125	3912 m³/h	2302	7808 m³/h	4594	9453 m³/h	5563
6"	159,3	DN 150	5560 m³/h	3272	11096 m³/h	6530	13436 m³/h	7907
8"	200,0	DN 200	8785 m³/h	5170	17533 m³/h	10318	21229 m³/h	12493
10"	250,0	DN 250	13744 m³/h	8088	27428 m³/h	16141	33211 m³/h	19544
12"	300,0	DN 300	19814 m³/h	11661	39544 m³/h	23271	47880 m³/h	28177

Flow Check - Inline flow meter

NEW: Modbus-RTU output
4...20 mA output for actual flow

Pulse output for total flow (counter reading), galvanically isolated or M-Bus (optionally)

Measuring device removable:
Dismounting of the whole measuring section is not necessary, no bypass required

Display turnable by 180°C
e.g. in case of reverse flow direction

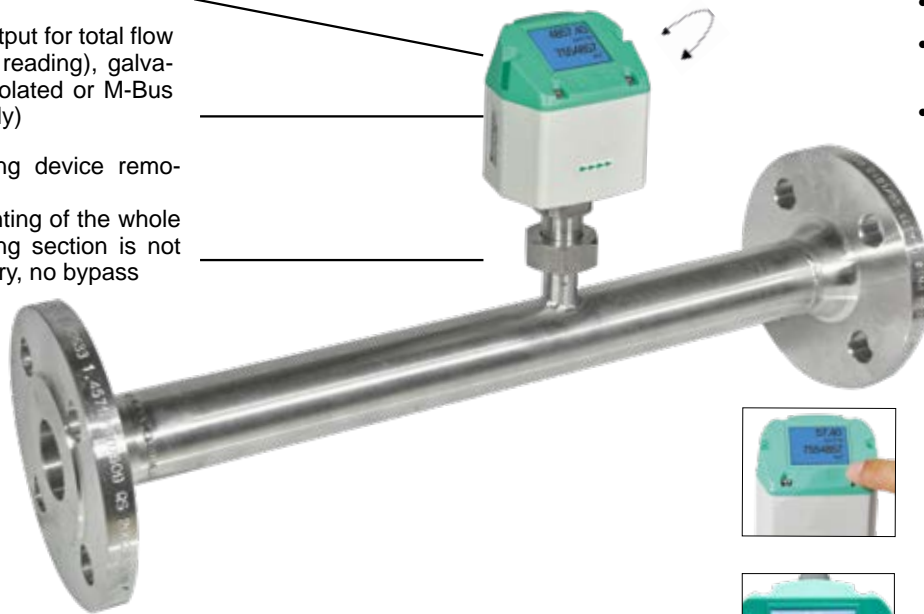

Display shows 2 values at the same time:

- Actual flow in m³/h, l/min,...
- Total consumption (counter reading) in m³, l
- resp. temperature measurement

Values indicated in the display turnable by 180°C, e.g. in case of overhead installation

Easy installation into the existing pipeline due to integrated measuring section and weld neck flange (according to EN 1092-1 PN 40)

High measuring accuracy due to defined measuring section (inlet and outlet section)



With a key stroke:

- Reset of counter reading
- Selection of units
- Zero-point adjustment, leak flow volume suppression



Option:

Bi-directional measurement. Blue or green arrows in the display indicate the direction of flow.

A meter reading is available for each flow direction.



Application-technological features of the flow meters Flow Check:

- Digital interfaces such as Modbus RTU, Ethernet (PoE) and M-Bus enable connection to higher-level systems such as energy management systems, building management systems, SPS,...
- Easy and affordable installation
- Units freely selectable via keys at the display m³/h, m³/min, l/min, l/s, kg/h, kg/min, kg/s, cfm
- Compressed air counter up to 1.999.999.999 m³. Resettable to „zero“ via keypad
- Analogue output 4...20 mA, pulse output (galvanically separated)
- High measuring accuracy also in the lower measuring range (ideal for leakage measurement)
- Negligibly small loss of pressure
- Calorimetric measuring principle, no additional pressure and temperature measurement necessary, no mechanically moved parts
- Comprehensive diagnosis functions can be read out at the display or by remote access via Modbus-RTU like e. g. exceeding Max./Min values °C, calibration cycle, error codes, serial number. All parameters can be read out and changed via Modbus

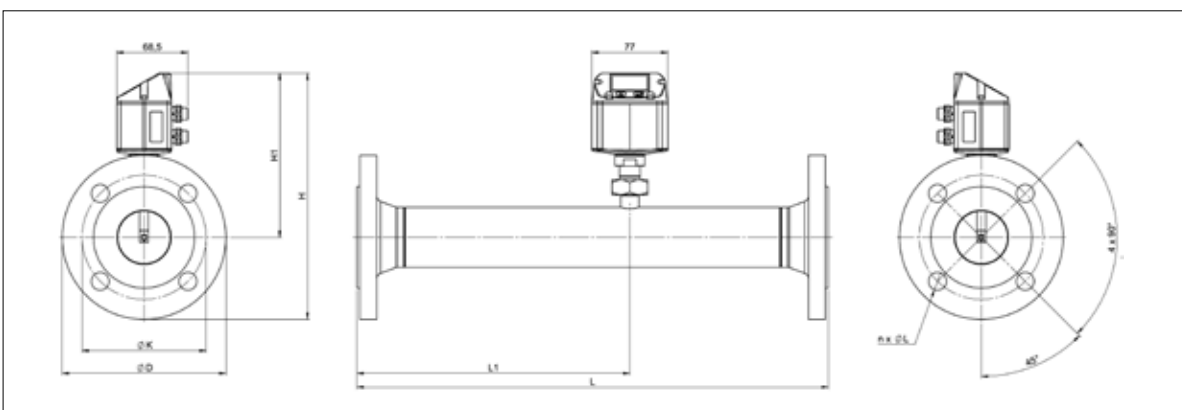

Measuring ranges flow Flow Check (Max version 185 m/s) for compressed air (ISO 1217: 1000 mbar, 20°C).
Measuring ranges for other types of gas see pages 64 to 67

Flange DIN EN 1092-1

Measuring section	Outer pipe dia. mm	Inner pipe dia. mm	Measuring range m ³ /h (cfm)		L mm	L1 mm	H mm	H1 mm	ØD mm	ØK mm	n x ØL
DN 15	21,3	16,1	90	50	300	210	213,2	165,7	95	65	4 x 14
DN 20	26,9	21,7	170	100	475	275	218,2	165,7	105	75	4 x 14
DN 25	33,7	27,3	290	170	475	275	223,2	165,7	115	85	4 x 14
DN 32	42,4	36,0	530	310	475	275	235,7	165,7	140	100	4 x 18
DN 40	48,3	41,9	730	430	475*	275	240,7	165,7	150	110	4 x 18
DN 50	60,3	53,1	1195	700	475*	275	248,2	165,7	165	125	4 x 18
DN 65	76,1	68,9	2050	1205	475*	275	268,2	175,7	185	145	8 x 18
DN 80	88,9	80,9	2840	1670	475*	275	275,7	175,7	200	160	8 x 18

*Attention: Shortened inlet section! Please observe the recommended minimum inlet section (length = 15 x inner diameter) on site

DESCRIPTION	ORDER-NO.
Flow Check 2F Flow meter with integr. DN 15 measuring section with Flange	2255332650
Flow Check 3F Flow meter with integr. DN 20 measuring section with Flange	2255332651
Flow Check 4F Flow meter with integr. DN 25 measuring section with Flange	2255332652
Flow Check 5F Flow meter with integr. DN 32 measuring section with Flange	2255332653
Flow Check 6F Flow meter with integr. DN 40 measuring section with Flange	2255332654
Flow Check 7F Flow meter with integr. DN 50 measuring section with Flange	2255332655
Flow Check 8F Flow meter with integr. DN 65 measuring section with Flange	2255332656
Flow Check 9F Flow meter with integr. DN 80 measuring section with Flange	2255332657
Bi-directional measurement - includes 2 x 4 ... 20 mA analog outputs and 2x pulse outputs. These are not available for Ethernet (PoE) and M-Bus interface	2255332627
High-pressure version PN 40	2255332658
ANSI flange 150 lbs (instead of DIN flanges)	2255332659
ANSI flange 300 lbs (instead of DIN flanges)	2255332660
Measuring ranges:	
Low Speed (50 m/s)	2255332661
Standard (92,7 m/s)	2255332662
High Speed (224 m/s)	2255332663
Options:	
Special measuring range for Flow Check according to customer requirements	2255332664
1 % Accuracy of m.v. ± 0,3 % of f.s.	2255332632
Ethernet-Interface for Flow Check/ Flow Check Universal	2255332633
Ethernet-Interface PoE for Flow Check/ Flow Check Universal	2255332634
M-Bus board for Flow Check/ Flow Check Universal	2255332635
ISO calibration certificate (5 calibration points) for Flow sensors	2255332642
Gas type: ____ (specify type of gas when ordering)	2255332643
Gas mixture: ____ (specify gas mixture when ordering)	2255332644
Real gas calibration	2255332645
Special cleaning oil and grease-free (e. g. oxygen application)	2255332646
Silicone-free version incl. cleaning free of oil and grease	2255332647
Additional calibration curve stored in the sensor (selectable via display)	2255332648
Certificate of origin	2255332649

TECHNICAL DATA Flow Check	
Parameters:	m ³ /h, l/min (1000 mbar, 20 °C) at compressed air or Nm ³ /h, NI/min (1013 mbar, 0 °C) for gases
Units adjustable via keys at display:	m ³ /h, m ³ /min, l/min, l/s, ft ³ /min, cfm, m/s, kg/h, kg/min, g/s, lb/min, lb/h
Sensor:	Thermal mass flow sensor
Measuring medium:	Air, gases
Gas types are adjustable over PMH service software or PMH data logger:	Air, nitrogen, argon, helium, CO ₂ , oxygen, vacuum
Measure range:	See table above
Accuracy: (m.v.: of meas. value) (f.s.: of full scale)	± 1.5 % of m.v. ± 0.3 % of f.s. on request ± 1.0 % of m.v. ± 0.3 % of f.s.
Operating temperature:	-30...80 °C
Operating pressure:	-1 to 16 bar optional to PN 40
Digital output:	RS 485 interface (Modbus-RTU), optional: Ethernet-Interface PoE), M-Bus
Analog output:	4...20 mA for m ³ /h e. g. l/min
Pulse output:	1 Pulse per m ³ or per liter galvanically isolated. Pulse value can be set on the display. Alternatively, the pulse output can be used as an alarm relay
Supply:	18...36 VDC, 5 W
Burden:	< 500 Ω
Housing:	Polycarbonate (IP 65)
Measuring section:	stainless steel, 1.4301 or 1.4571
Process connection:	Flange (to DIN EN 1092-1 e. g. ANSI 150 lbs or ANSI 300 lbs)
Mounting position:	Any

Further accessories see pages 54 to 58

Flow Check - Inline flow meter

NEW: Modbus-RTU output
4...20 mA output for actual flow

Pulse output for total flow (counter reading), galvanically isolated or M-Bus (optionally)

Measuring device removable:
Dismounting of the whole measuring section is not necessary, no bypass required

Display can be rotated by 180°C e. g. in case of reverse flow direction

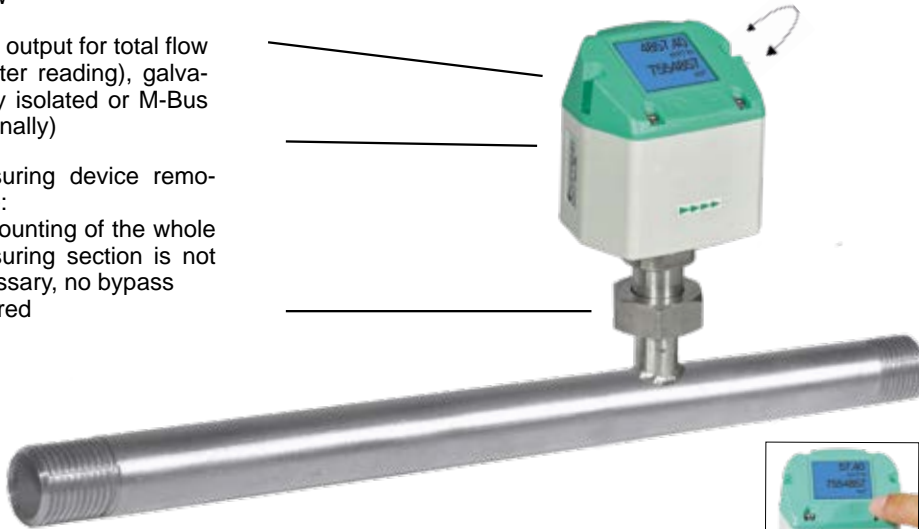

Display shows 2 values at the same time:

- Actual flow in m³/h, l/min,...
- Total consumption (counter reading) in m³, l
- resp. temperature measurement

Values indicated in the display turnable by 180°C, e.g. in case of overhead installation

With a key stroke:

- Reset of counter reading
- Selection of units
- Zero-point adjustment, leak flow volume suppression



Option:

Bi-directional measurement. Blue or green arrows in the display indicate the direction of flow.

A meter reading is available for each flow direction.



Easy installation in existing piping through integrated measuring section (1/4" to 2")

High measuring accuracy due to defined measuring section (inlet and outlet section)

Application-technological features of the flow meters Flow Check:

- Digital interfaces such as Modbus RTU, Ethernet (PoE) and M-Bus enable connection to higher-level systems such as energy management systems, building management systems, SPS,...
- Easy and affordable installation
- Units freely selectable via keys at the display m³/h, m³/min, l/min, l/s, kg/h, kg/min, kg/s, cfm
- Compressed air counter up to 1.999.999.999 m³. Resetable to „zero“ via keypad
- Analogue output 4...20 mA, pulse output (galvanically separated)
- High measuring accuracy also in the lower measuring range (ideal for leakage measurement)
- Negligibly small loss of pressure
- Calorimetric measuring principle, no additional pressure and temperature measurement necessary, no mechanically moved parts
- Comprehensive diagnosis functions can be read out at the display or by remote access via Modbus-RTU like e. g. exceeding Max./Min values °C, calibration cycle, error codes, serial number. All parameters can be read out and changed via Modbus

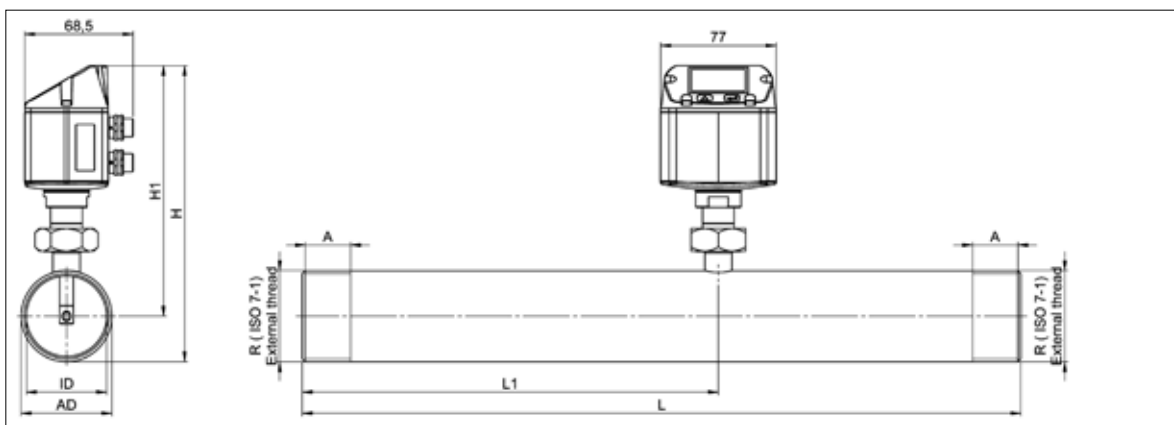

Measuring ranges flow Flow Check (Max. version 185 m/s) for compressed air (ISO 1217: 1000 mbar, 20 ° C)									
Measuring ranges for other types of gas see pages 64 to 67									
Measuring section	Outer pipe dia. mm	Inner pipe dia. mm	Measuring ranges		L mm	L1 mm	H mm	H1 mm	A mm
			m³/h	cfm					
R 1/4"	13,7	8,9	105 l/min	3,6	194	137	174,7	165,7	15
R 1/2"	21,3	16,1	90	50	300	210	176,4	165,7	20
R 3/4"	26,9	21,7	170	100	475	275	179,2	165,7	20
R 1"	33,7	27,3	290	170	475	275	182,6	165,7	25
R 1 1/4"	42,4	36,0	530	310	475	275	186,9	165,7	25
R 1 1/2"	48,3	41,9	730	430	475*	275	186,9	165,7	25
R 2"	60,3	53,1	1195	700	475*	275	195,9	165,7	30

*Attention: Shortened inlet section! Please observe the recommended minimum inlet section (length = 15 x inner diameter) on site

DESCRIPTION	ORDER-NO. Stainless steel 1.4571	ORDER-NO. Stainless steel 1.4301	TECHNICAL DATA Flow Check
Flow Check 1 Flow meter with 1/4" measuring section		2255330393	Parameters: m³/h, l/min (1000 mbar, 20 ° C) at compressed air or Nm³/h, NI/min (1013 mbar, 0 ° C) for gases Units adjustable via keys at display: m³/h, m³/min, l/min, l/s, ft/min, cfm, m/s, kg/h, kg/min, g/s, lb/min, lb/h Sensor: Thermal mass flow sensor Measuring medium: Air, gases Gas types are adjustable over PMH service software or PMH data logger: Air, nitrogen, argon, helium, CO2, oxygen, vacuum Measure range: See table above Accuracy: ± 1.5 % of m.v. ± 0.3 % of f.s. (m.v.: of meas. value) (f.s.: of full scale) on request ± 1.0 % of m.v. ± 0.3 % of f.s. Operating temperature: -30...80 °C Operating pressure: -1 to 16 bar optional to PN 40 Digital output: RS 485 interface (Modbus-RTU), optional: Ethernet-Interface PoE), M-Bus Analog output: 4...20 mA for m³/h e. g. l/min Pulse output: 1 Pulse per m³ or per liter galvanically isolated. Pulse value can be set on the display. Alternatively, the pulse output can be used as an alarm relay Supply: 18...36 VDC, 5 W Burden: < 500 Ω Housing: Polycarbonate (IP 65) Measuring section: Stainless steel, 1.4301 or 1.4571 Process connection: R 1/4" to R 2" (BSP British Standard Piping) or 1/2" to 2" NPT-thread Mounting position: Any
Flow Check 2 Flow meter with 1/2" measuring section	2255332738	2255330394	
Flow Check 3 Flow meter with 3/4" measuring section	2255332739	2255330395	
Flow Check 4 Flow meter with 1" measuring section	2255332740	2255330396	
Flow Check 5 Flow meter with 1 1/4" measuring section	2255332741	2255330397	
Flow Check 6 Flow meter with 1 1/2" measuring section	2255332742	2255330398	
Flow Check 7 Flow meter with 2" measuring section		2255330399	
Bi-directional measurement - includes 2 x 4 ... 20 mA analog outputs and 2x pulse outputs. These are omitted for Ethernet (PoE) and M-Bus		2255332627	
High-pressure version PN 40		2255332658	
Measuring ranges:			
Low Speed (50 m/s)		2255332661	
Standard (92,7 m/s)		2255332662	
High Speed (224 m/s)		2255332663	
Options:			
Special measuring range for Flow Check according to customer requirements		2255332664	
1 % Accuracy of m.v. ± 0,3 % of f.s.		2255332632	
Ethernet-Interface for Flow Check/ Flow Check Universal		2255332633	
Ethernet-Interface PoE for Flow Check/ Flow Check Universal		2255332634	
M-Bus board for Flow Check/ Flow Check Universal		2255332635	
ISO calibration certificate (5 calibration points) for Flow sensors		2255332642	
Gas type: ____ (specify type of gas when ordering)		2255332643	
Gas mixture: ____ (specify gas mixture when ordering)		2255332644	
Real gas calibration		2255332645	
Special cleaning oil and grease-free (e. g. oxygen application)		2255332646	
Silicone-free version incl. cleaning free of oil and grease		2255332647	
Additional calibration curve stored in the sensor (selectable via display)		2255332648	
Certificate of origin		2255332649	

Further accessories see pages 54 to 86



Accessories Flow Check/ Flow Check Universal

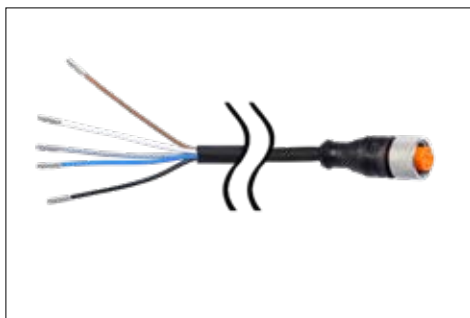

DESCRIPTION	ORDER-NO.
Connection cable for Flow/ PDP series, 5 m	2255460213
Connection cable for Flow/ PDP series, 10 m	2255460214
Connection cable for Flow/ PDP series, 20 m	2255460215
Cable for alarm / pulse output, with M12 plug, 5 m	2255332609
Cable for alarm / pulse output, with M12 plug, 10 m	2255332610
Connection cable for Flow/ PDP series, 5 m shielded	2255332607
Connection cable for Flow/ PDP series, 10 m shielded	2255332608



DESCRIPTION	ORDER-NO.
Ethernet connection cable, length 5 m, M12 connector x-coded (8 pol.) on RJ 45 plug	2255332614
Ethernet connection cable, length 10 m, M12 connector x-coded (8 pol.) on RJ 45 plug	2255332615



DESCRIPTION	ORDER-NO.
M12 T-connector for Flow Check/ Flow Check Universal for connecting several sensors to an M-Bus or Modbus network	2255332666



DESCRIPTION	ORDER-NO.
M12 plug for Flow Check/ Flow Check Universal	2255332611
M12 plug angled 90°	2255332612

Accessories Flow Check Universal



DESCRIPTION	ORDER-NO.
Drilling jig incl. drill (Ø 13 mm)	2255332667



DESCRIPTION	ORDER-NO.
High pressure protection recommended for installations from 10 to 50 bar (Flow Check Universal)	2255332668

- Only suitable for Flow Check Universal with sensor length: 160 mm, 220 mm, 300 mm. For further sensor length on request



DESCRIPTION	ORDER-NO.
Thickness meter PMH 0495 incl. case and calibration block	2255332669



DESCRIPTION	ORDER-NO.
Welding Nipple, L = 35 mm, male thread, R 1/2" stainless steel 1.4301	2255332670
Welding Nipple, L = 35 mm, male thread, R 1/2" stainless steel 1.4571	2255332671



DESCRIPTION	ORDER-NO.
Ball valve I / I G 1/2" stainless steel	2255332672



Accessories Flow Check Universal

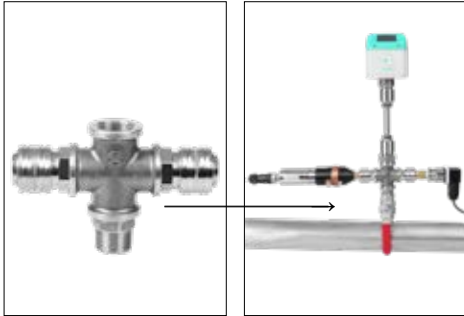

DESCRIPTION	ORDER-NO.
X-connection for connection of pressure and dew point sensor at the same measuring point (incl. 2x quick-release coupling)	2255332673



DESCRIPTION	ORDER-NO.
Thread adapter G 1/2" female thread to NPT 1/2" male thread	2255332674

Accessories for all Flow Check



DESCRIPTION	ORDER-NO.
Power supply in wall housing for max. 2 sensors of the Flow / PDP Sens series 100-240 V, 23 VA, 50-60 Hz / 24 VDC, 0.35 A	2255332616
Power supply in wall housing for max. 4 sensors of the Flow Check/ Flow Check Universal series 100-240 V, 23 VA, 50-60 Hz / 24 VDC, 0.35 A	2255332690



DESCRIPTION	ORDER-NO.
Plug-in power supply 100-240 V, AC / 24 V for Flow / PDP Sens	2255332617

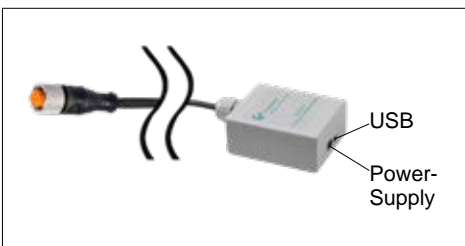

DESCRIPTION	ORDER-NO.
PMH service software incl. PC connection set, USB port and interface adapter to the sensor	2255332597



DESCRIPTION	ORDER-NO.
External gateway PROFIBUS for connection to integrated RS 485 interface	2255332467
External gateway PROFINET for connection to integrated RS 485 interface	2255332676



DESCRIPTION	ORDER-NO.
Transport case for all sensors (dimensions: 500 x 360 x 120 mm)	2255332518

Practical accessories measuring sections



Measuring section 1/2"

EXTERNAL THREAD	PIPE (OUTSIDE Ø THICKNESS)	TOTAL LENGTH	ORDER-NO.
R 1/2"	21,3 x 2,6 mm	500 mm	2255332678
R 3/4"	26,9 x 2,6 mm	600 mm	2255332679
R 1"	33,7 x 3,2 mm	750 mm	2255332680
R 1 1/4"	42,4 x 3,2 mm	900 mm	2255332681
R 1 1/2"	48,3 x 3,2 mm	1000 mm	2255332682
R 2"	60,3 x 3,6 mm	1250 mm	2255332683
R 2 1/2"	76,1 x 3,6 mm	1500 mm	2255332684
From DN 80 with flange DIN 2633			
DN 80/88,9	88,9 x 2,0 mm	1850 mm	2255332685
DN 100/114,3	114,3 x 2,0 mm	2104 mm	2255332686
DN 125/139,7	139,7 x 3,0 mm	2860 mm	2255332687
DN 150/168,3	168,3 x 3,0 mm	3110 mm	2255332688

Measuring sections for precise measurements:

Measuring section in stainless steel 1.4301 incl. ball valve, up to DN 65 (R 2 1/2") with R male thread, from DN 80 with welding neck to DIN 2633.

Useful accessories-spot drilling collars for compressed air lines



If there is no measuring site with 1/2" ball valve present it can be set up by means of spot drilling collars

The spot drilling collar is imposed onto the pipe and tightened via thread rods. The enveloping rubber gasket is pressure-tight up to 10 bar. By means of the drilling jig it is possible to drill through the 1/2" ball valve into the existing pipe.

Important: Please indicate the exact outer diameter of the existing pipe when placing the order resp. please select the suitable spot drilling collar from the adjoining list.

DESCRIPTION	DN	ORDER-NO.
Spot drilling collar for pipe-Ø 032 - 036 mm, length: 100 mm*		2255332689
Spot drilling collar for pipe-Ø 036 - 040 mm, length: 100 mm*		2255332691
Spot drilling collar for pipe-Ø 040 - 044 mm, length: 150 mm*		2255332692
Spot drilling collar for pipe-Ø 044 - 051 mm, length: 200 mm*		2255332693
Spot drilling collar for pipe-Ø 048 - 055 mm, length: 200 mm*	40	2255332694
Spot drilling collar for pipe-Ø 052 - 059 mm, length: 200 mm*		2255332695
Spot drilling collar for pipe-Ø 057 - 064 mm, length: 200 mm*	50	2255332696
Spot drilling collar for pipe-Ø 063 - 070 mm, length: 200 mm*		2255332697
Spot drilling collar for pipe-Ø 070 - 077 mm, length: 200 mm*	65	2255332698
Spot drilling collar for pipe-Ø 075 - 083 mm, length: 200 mm*		2255332699
Spot drilling collar for pipe-Ø 082 - 090 mm, length: 200 mm*		2255332700
Spot drilling collar for pipe-Ø 087 - 097 mm, length: 200 mm*	80	2255332701
Spot drilling collar for pipe-Ø 095 - 104 mm, length: 200 mm*		2255332702
Spot drilling collar for pipe-Ø 102 - 112 mm, length: 200 mm*		2255332703
Spot drilling collar for pipe-Ø 108 - 118 mm, length: 200 mm*	100	2255332704
Spot drilling collar for pipe-Ø 118 - 128 mm, length: 200 mm*		2255332705
Spot drilling collar for pipe-Ø 125 - 135 mm, length: 200 mm*		2255332706
Spot drilling collar for pipe-Ø 133 - 144 mm, length: 200 mm*	125	2255332707
Spot drilling collar for pipe-Ø 145 - 155 mm, length: 250 mm*		2255332708
Spot drilling collar for pipe-Ø 151 - 161 mm, length: 250 mm*	150	2255332709
Spot drilling collar for pipe-Ø 159 - 170 mm, length: 250 mm*		2255332710
Spot drilling collar for pipe-Ø 168 - 180 mm, length: 250 mm*		2255332711
Spot drilling collar for pipe-Ø 180 - 191 mm, length: 250 mm*	175	2255332712
Spot drilling collar for pipe-Ø 193 - 203 mm, length: 300 mm*		2255332713
Spot drilling collar for pipe-Ø 200 - 210 mm, length: 300 mm*		2255332714
Spot drilling collar for pipe-Ø 209 - 220 mm, length: 300 mm*	200	2255332715

*Incl. 1/2" ball valve

* not suitable for copper and plastic pipes

PMH Service Software - for Flow Check meters

... including PC connection set, USB adapter and interface adapter to the meter



The flow sensors Flow Check can be connected to the PC and the following adjustments can be carried out by means of the PMH Service Software:

- Selection of the gas type (Compressed air, CO₂, N₂O, N₂, O₂, NG, Ar, CH₄)
- Selection of the units for flow, velocity, temperature, consumption
- Selection of units: m³/h, Nm³/h, m³/min, Nm³/min, ltr/h, Nltr/h, ltr/min, Nltr/min, ltr/s, Nltr/s, cfm, SCFM, kg/h, kg/min, kg/s
- Adjustment of the reference temperature, reference pressure
- Zero-point adjustment, low flow cut-off adjustable
- Modbus and M-Bus settings
- Scaling of the 4...20 mA analog output
- Reading out of: Version number, production date, serial number, date of last calibration
- Adjustment of alarm limits
- Reset to factory defaults
- Transfer of updates to the sensor (firmware update, language update)

DESCRIPTION	ORDER-NO.
PMH Service Software for Flow/ PDP sensors incl. PC connection set, USB connection and interface adapter to the sensor	2255332597

Measuring ranges Flow Check Universal

Measuring ranges Low-Speed version

Flow measuring ranges Flow Check Universal - insertion meter													
Inner pipe diameter			Low-Speed version (50 m/s)										Re- com- men- ded probe length
			Measuring range Nm ³ /h * / [cfm]										
Inch	mm	DN	Air**	Nitrogen (N ₂)	Argon (Ar)	Oxygen (O ₂)	Carbon dioxide (CO ₂)	Methane Natural gas (CH ₄)	Helium (He)	Hydrogen (H ₂)	Propane (C ₃ H ₈)		
1/2"	16,1	DN 15	24 [14]	22 [13]	38 [22]	23 [13]	24 [14]	14 [8]	10 [6]	7 [4]	11 [6]	160 mm - 6,299 inch	
3/4"	21,7	DN 20	48 [28]	44 [26]	75 [44]	45 [26]	47 [27]	28 [16]	20 [11]	14 [8]	22 [13]		
1"	27,3	DN 25	79 [46]	73 [43]	124 [73]	75 [44]	78 [46]	47 [27]	33 [19]	23 [13]	36 [21]		
1 1/4"	36,0	DN 32	143 [84]	132 [77]	224 [132]	136 [80]	142 [83]	85 [50]	60 [35]	42 [24]	66 [38]		
1 1/2"	41,9	DN 40	197 [116]	181 [107]	309 [182]	188 [111]	195 [115]	117 [68]	82 [48]	58 [34]	90 [53]		
2"	53,1	DN 50	323 [190]	297 [175]	506 [297]	308 [181]	320 [188]	191 [112]	135 [79]	95 [55]	148 [87]	220 mm - 8,661 inch	
2 1/2"	68,9	DN 65	554 [326]	509 [300]	866 [510]	528 [311]	548 [322]	328 [193]	231 [136]	162 [95]	254 [150]		
3"	80,9	DN 80	768 [452]	706 [415]	1201 [706]	732 [431]	760 [447]	454 [267]	321 [188]	225 [132]	353 [207]		
4"	110,0	DN 100	1426 [839]	1311 [772]	2230 [1312]	1360 [800]	1411 [830]	844 [496]	596 [350]	418 [246]	655 [386]		
5"	133,7	DN 125	2110 [1241]	1940 [1141]	3299 [1941]	2011 [1183]	2088 [1228]	1248 [734]	881 [519]	619 [364]	970 [570]		
6"	159,3	DN 150	2999 [1765]	2758 [1623]	4689 [2759]	2859 [1682]	2967 [1746]	1774 [1044]	1253 [737]	880 [518]	1379 [811]	300 mm - 11,811 inch	
8"	200,0	DN 200	4738 [2788]	4357 [2564]	7409 [4360]	4517 [2658]	4689 [2759]	2804 [1650]	1980 [1165]	1391 [819]	2178 [1282]		
10"	250,0	DN 250	7413 [4362]	6817 [4011]	11590 [6820]	7067 [4159]	7336 [4317]	4386 [2581]	3098 [1823]	2177 [1281]	3408 [2005]		
12"	300,0	DN 300	10687 [6289]	9828 [5783]	16710 [9833]	10189 [5996]	10576 [6224]	6324 [3721]	4466 [2628]	3138 [1847]	4914 [2891]		

Flow measuring ranges Flow Check Universal - insertion meter															
Inner pipe diameter			Low-Speed version (50 m/s)										Re- com- men- ded probe length		
			Measuring range Nm ³ /h * / [cfm]												
Inch	mm	DN	Corgon ®18	Corgon ®10	Corgon ®20	Forming gas 90% N ₂ + 10% H ₂	Natural gas L (CH ₄)	Biogas 50%CH ₄ + 50% CO ₂	Biogas 60% CH ₄ + 40% CO ₂	LPG 60% C ₃ H ₈ + 40% C ₄ H ₁₀	LPG 50% C ₃ H ₈ + 50% C ₄ H ₁₀	Nitrous (N ₂ O)	Ethyne/ Acetylene (C ₂ H ₂)		
1/2"	16,1	DN 15	35 [21]	36 [21]	35 [20]	20 [12]	15 [9]	17 [10]	17 [10]	13 [7]	12 [7]	24 [14]	13 [8]	160 mm - 6,299 inch	
3/4"	21,7	DN 20	70 [41]	71 [42]	69 [40]	40 [23]	30 [17]	34 [20]	34 [20]	25 [15]	25 [14]	47 [27]	26 [15]		
1"	27,3	DN 25	116 [68]	119 [70]	115 [67]	67 [39]	50 [29]	57 [34]	56 [33]	42 [24]	41 [24]	78 [45]	44 [26]		
1 1/4"	36,0	DN 32	209 [123]	214 [126]	208 [122]	121 [71]	91 [53]	104 [61]	101 [59]	76 [45]	74 [44]	140 [89]	80 [47]		
1 1/2"	41,9	DN 40	288 [170]	296 [174]	286 [168]	167 [98]	125 [73]	143 [84]	140 [82]	105 [62]	103 [60]	194 [114]	110 [65]		
2"	53,1	DN 50	472 [278]	484 [284]	468 [275]	273 [161]	205 [120]	235 [138]	229 [135]	172 [101]	168 [99]	317 [186]	181 [106]	220 mm - 8,661 inch	
2 1/2"	68,9	DN 65	809 [476]	829 [488]	803 [472]	469 [276]	351 [207]	403 [237]	393 [231]	295 [173]	288 [169]	543 [320]	311 [183]		
3"	80,9	DN 80	1121 [660]	1149 [676]	1112 [654]	649 [382]	487 [286]	558 [328]	544 [320]	409 [240]	400 [235]	753 [443]	430 [253]		
4"	110,0	DN 100	2082 [1225]	2134 [1255]	2066 [1216]	1206 [710]	905 [532]	1037 [610]	1011 [595]	759 [447]	742 [437]	1399 [823]	800 [470]		
5"	133,7	DN 125	3080 [1813]	3156 [1857]	3056 [1798]	1785 [1050]	1338 [787]	1534 [903]	1496 [880]	1123 [661]	1098 [646]	2069 [1217]	1183 [696]		
6"	159,3	DN 150	4378 [2576]	4486 [2640]	4344 [2556]	2537 [1493]	1903 [1119]	2181 [1283]	2126 [1251]	1597 [939]	1561 [919]	2941 [1731]	1682 [990]	300 mm - 11,811 inch	
8"	200,0	DN 200	6918 [4071]	7089 [4171]	6864 [4039]	4009 [2359]	3006 [1769]	3446 [2028]	3359 [1977]	2523 [1485]	2467 [1452]	4647 [2735]	2658 [1564]		
10"	250,0	DN 250	10823 [6369]	11090 [6526]	10738 [6319]	6271 [3690]	4703 [2768]	5392 [3173]	5255 [3093]	3947 [2323]	3860 [2271]	7270 [4278]	4158 [2447]		
12"	300,0	DN 300	15604 [9183]	15988 [9409]	15481 [9110]	9042 [5321]	6781 [3990]	7774 [4575]	7577 [4459]	5691 [3349]	5565 [3275]	10482 [6168]	5995 [3528]		

* Nm³/h according to DIN 1343: 0 °C, 1013,25 hPa for gases

** ISO 1217: 20 °C, 1000 hPa in air

If you want to measure the consumption / flow rate of a specific gas mixture, ask us.
We can offer a real gas adjustment under process conditions on request.

Measuring ranges Standard version

Flow measuring ranges Flow Check Universal - insertion meter												
Inner pipe diameter			Standard version (92,7 m/s)									Recom- men- ded probe length
			Measuring range Nm ³ /h * / [cfm]									
Inch	mm	DN	Air**	Nitrogen (N ₂)	Argon (Ar)	Oxygen (O ₂)	Carbon dioxide (CO ₂)	Methane Natural gas (CH ₄)	Helium (He)	Hydrogen (H ₂)	Propane (C ₃ H ₈)	
1/2"	16,1	DN 15	45 [26]	41 [24]	71 [41]	43 [25]	45 [26]	26 [15]	19 [11]	13 [7]	20 [12]	160 mm - 6,299 inch
3/4"	21,7	DN 20	89 [52]	81 [48]	139 [81]	84 [49]	88 [51]	52 [31]	37 [21]	26 [15]	40 [24]	
1"	27,3	DN 25	147 [86]	135 [79]	230 [135]	140 [82]	146 [86]	87 [51]	61 [36]	43 [25]	67 [39]	
1 1/4"	36,0	DN 32	266 [156]	244 [144]	416 [245]	253 [149]	263 [155]	157 [92]	111 [65]	78 [46]	122 [72]	
1 1/2"	41,9	DN 40	366 [215]	337 [198]	573 [337]	349 [205]	363 [213]	217 [127]	153 [90]	107 [63]	168 [99]	
2"	53,1	DN 50	600 [353]	551 [324]	938 [552]	572 [336]	593 [349]	355 [208]	250 [147]	176 [103]	275 [162]	
2 1/2"	68,9	DN 65	1028 [604]	945 [556]	1607 [945]	980 [576]	1017 [598]	608 [358]	429 [252]	301 [177]	472 [278]	220 mm - 8,661 inch
3"	80,9	DN 80	1424 [838]	1309 [770]	2227 [1310]	1358 [799]	1409 [829]	842 [496]	595 [350]	418 [246]	654 [385]	
4"	110,0	DN 100	2644 [1556]	2432 [1431]	4135 [2433]	2521 [1484]	2617 [1540]	1565 [921]	1105 [650]	776 [457]	1216 [715]	
5"	133,7	DN 125	3912 [2302]	3597 [2117]	6116 [3599]	3729 [2195]	3871 [2278]	2315 [1362]	1635 [962]	1149 [676]	1798 [1058]	
6"	159,3	DN 150	5560 [3272]	5113 [3009]	8693 [5116]	5301 [3119]	5502 [3238]	3290 [1936]	2324 [1367]	1633 [961]	2556 [1504]	300 mm - 11,811 inch
8"	200,0	DN 200	8785 [5170]	8079 [4754]	13736 [8083]	8376 [4929]	8694 [5116]	5198 [3059]	3672 [2160]	2580 [1518]	4039 [2377]	
10"	250,0	DN 250	13744 [8088]	12638 [7437]	21488 [12646]	13103 [7711]	13601 [8004]	8133 [4786]	5744 [3380]	4036 [2375]	6319 [3718]	
12"	300,0	DN 300	19814 [11661]	18221 [10723]	30980 [18232]	18891 [11117]	19609 [11539]	11725 [6900]	8281 [4873]	5819 [3424]	9110 [5361]	

Flow measuring ranges Flow Check Universal - insertion meter														
Inner pipe dia- meter			Standard version (92,7 m/s)											Recom- men- ded probe length
			Measuring range Nm ³ /h * / [cfm]											
Inch	mm	DN	Corgon ®18	Corgon ®10	Corgon ®20	Forming gas 90% N ₂ + 10% H ₂	Natural gas L (CH ₄)	Biogas 50% CH ₄ + 50% CO ₂	Biogas 60% CH ₄ + 40% CO ₂	LPG 60% C ₃ H ₈ + 40% C ₄ H ₁₀	LPG 50% C ₃ H ₈ + 50% C ₄ H ₁₀	Nitrous (N ₂ O)	Ethyne/ Acetylene (C ₂ H ₂)	
1/2"	16,1	DN 15	66 [39]	68 [40]	66 [38]	38 [22]	28 [17]	33 [19]	32 [19]	24 [14]	23 [13]	44 [26]	25 [15]	160 mm - 6,299 inch
3/4"	21,7	DN 20	130 [76]	133 [78]	129 [75]	75 [44]	56 [33]	64 [38]	63 [37]	47 [27]	46 [27]	87 [51]	49 [29]	
1"	27,3	DN 25	215 [126]	220 [130]	213 [125]	124 [73]	93 [55]	107 [63]	104 [61]	78 [46]	76 [45]	144 [85]	82 [48]	
1 1/4"	36,0	DN 32	388 [228]	398 [234]	385 [227]	225 [132]	168 [99]	193 [114]	188 [111]	141 [83]	138 [81]	261 [153]	149 [87]	
1 1/2"	41,9	DN 40	535 [315]	548 [322]	531 [312]	310 [182]	232 [136]	266 [157]	260 [153]	195 [114]	191 [112]	359 [211]	205 [121]	
2"	53,1	DN 50	876 [515]	897 [528]	869 [511]	507 [298]	380 [224]	436 [256]	425 [250]	319 [188]	312 [183]	588 [346]	336 [198]	
2 1/2"	68,9	DN 65	1500 [883]	1537 [905]	1489 [876]	869 [511]	652 [383]	747 [440]	728 [428]	547 [322]	535 [315]	1008 [593]	576 [339]	220 mm - 8,661 inch
3"	80,9	DN 80	2079 [1223]	2130 [1254]	2063 [1214]	1205 [709]	903 [531]	1036 [609]	1009 [594]	758 [446]	741 [436]	1397 [822]	799 [470]	
4"	110,0	DN 100	3861 [2272]	3956 [2328]	3831 [2254]	2237 [1316]	1678 [987]	1923 [1132]	1875 [1103]	1408 [828]	1377 [810]	2594 [1526]	1483 [873]	
5"	133,7	DN 125	5711 [3361]	5852 [3444]	5666 [3335]	3309 [1947]	2482 [1460]	2845 [1674]	2773 [1632]	2083 [1226]	2037 [1198]	3837 [2258]	2194 [1291]	
6"	159,3	DN 150	8118 [4777]	8318 [4895]	8054 [4740]	4704 [2768]	3528 [2076]	4044 [2380]	3942 [2320]	2961 [1742]	2895 [1704]	5453 [3209]	3119 [1835]	300 mm - 11,811 inch
8"	200,0	DN 200	12827 [7548]	13143 [7734]	12726 [7489]	7432 [4374]	5574 [3280]	6390 [3760]	6229 [3665]	4678 [2753]	4575 [2692]	8616 [5071]	4928 [2900]	
10"	250,0	DN 250	20066 [11809]	20560 [12100]	19908 [11716]	11627 [6842]	8720 [5132]	9997 [5883]	9744 [5734]	7319 [4307]	7157 [4212]	13480 [7932]	7709 [4537]	
12"	300,0	DN 300	28930 [17025]	29643 [17444]	28702 [16891]	16763 [9865]	12572 [7399]	14413 [8482]	14048 [8267]	10552 [6209]	10318 [6072]	19434 [11437]	11115 [6541]	

* Nm³/h according to DIN 1343: 0 °C, 1013,25 hPa for gases

** ISO 1217: 20 °C, 1000 hPa in air

If you want to measure the consumption / flow rate of a specific gas mixture, ask us.
We can offer a real gas adjustment under process conditions on request.

Measuring ranges Max version

Flow measuring ranges Flow Check Universal - insertion meter													Re- com- men- ded probe length
Inner pipe diameter			Max version (185,0 m/s)										
			Measuring range Nm ³ /h * / [cfm]										
Inch	mm	DN	Air**	Nitrogen (N ₂)	Argon (Ar)	Oxygen (O ₂)	Carbon dioxide (CO ₂)	Methane Natural gas (CH ₄)	Helium (He)	Hydrogen (H ₂)	Propane (C ₃ H ₈)		
1/2"	16,1	DN 15	90 [53]	83 [49]	142 [83]	86 [51]	90 [52]	53 [31]	38 [22]	26 [15]	41 [24]	160 mm - 6,299 inch	
3/4"	21,7	DN 20	177 [104]	163 [96]	278 [163]	169 [99]	175 [103]	105 [61]	74 [43]	52 [30]	81 [48]		
1"	27,3	DN 25	294 [173]	271 [159]	460 [271]	280 [165]	291 [171]	174 [102]	123 [72]	86 [50]	135 [79]		
1 1/4"	36,0	DN 32	531 [312]	488 [287]	830 [489]	506 [298]	525 [309]	314 [185]	222 [130]	156 [91]	244 [143]		
1 1/2"	41,9	DN 40	732 [430]	673 [396]	1144 [673]	697 [410]	724 [426]	433 [254]	305 [180]	215 [126]	336 [198]		
2"	53,1	DN 50	1197 [704]	1101 [648]	1872 [1101]	1141 [671]	1185 [697]	708 [417]	500 [294]	351 [206]	550 [324]		
2 1/2"	68,9	DN 65	2051 [1207]	1886 [1110]	3207 [1887]	1955 [1151]	2030 [1194]	1214 [714]	857 [504]	602 [354]	943 [555]	220 mm - 8,661 inch	
3"	80,9	DN 80	2842 [1672]	2614 [1538]	4444 [2615]	2710 [1594]	2813 [1655]	1682 [989]	1188 [699]	834 [491]	1307 [769]		
4"	110,0	DN 100	5278 [3106]	4854 [2856]	8252 [4856]	5032 [2961]	5223 [3074]	3123 [1838]	2206 [1298]	1550 [912]	2427 [1428]		
5"	133,7	DN 125	7807 [4594]	7179 [4225]	12206 [7183]	7443 [4380]	7726 [4546]	4620 [2718]	3263 [1920]	2293 [1349]	3589 [2112]		
6"	159,3	DN 150	11096 [6530]	10204 [6005]	17349 [10210]	10579 [6226]	10981 [6462]	6566 [3864]	4637 [2729]	3259 [1917]	5102 [3002]		
8"	200,0	DN 200	17533 [10318]	16123 [9488]	27413 [16132]	16716 [9837]	17351 [10211]	10375 [6105]	7328 [4312]	5149 [3030]	8061 [4744]	300 mm - 11,811 inch	
10"	250,0	DN 250	27428 [16141]	25223 [14843]	42884 [25237]	26150 [15389]	27143 [15974]	16231 [9552]	11463 [6746]	8055 [4740]	12611 [7421]		
12"	300,0	DN 300	39544 [23271]	36364 [21400]	61827 [36385]	37701 [22187]	39133 [23030]	23400 [13771]	16527 [9726]	11614 [6834]	18182 [10700]		

Flow measuring ranges Flow Check Universal - insertion meter														Re- com- men- ded probe length
Inner pipe dia- meter			Max version (185,0 m/s)											
			Measuring range Nm ³ /h * / [cfm]											
Inch	mm	DN	Corgon @18	Corgon @10	Corgon @20	Forming gas 90% N ₂ + 10% H ₂	Natural gas L(CH ₄)	Biogas 50% CH ₄ + 50% CO ₂	Biogas 60% CH ₄ + 40% CO ₂	LPG 60% C ₃ H ₈ + 40% C ₄ H ₁₀	LPG 50% C ₃ H ₈ + 50% C ₄ H ₁₀	Nitrous (N ₂ O)	Ethyne/ Acetylene (C ₂ H ₂)	
1/2"	16,1	DN 15	132 [78]	136 [80]	131 [77]	76 [45]	57 [33]	66 [38]	64 [37]	48 [28]	47 [27]	89 [52]	51 [30]	160 mm - 6,299 inch
3/4"	21,7	DN 20	259 [152]	266 [156]	257 [151]	150 [88]	112 [66]	129 [76]	126 [74]	94 [55]	92 [54]	174 [102]	99 [58]	
1"	27,3	DN 25	430 [253]	440 [259]	426 [251]	249 [146]	187 [110]	214 [126]	208 [122]	156 [92]	153 [90]	289 [170]	165 [97]	
1 1/4"	36,0	DN 32	775 [456]	795 [467]	769 [453]	449 [264]	337 [198]	386 [227]	376 [221]	283 [166]	276 [162]	521 [306]	298 [175]	
1 1/2"	41,9	DN 40	1068 [629]	1095 [644]	1060 [624]	619 [364]	464 [273]	532 [313]	519 [305]	389 [229]	381 [224]	718 [422]	410 [241]	
2"	53,1	DN 50	1748 [1029]	1791 [1054]	1734 [1020]	1013 [596]	759 [447]	871 [512]	849 [499]	637 [375]	623 [367]	1174 [691]	671 [395]	
2 1/2"	68,9	DN 65	2995 [1762]	3069 [1806]	2971 [1748]	1735 [1021]	1301 [766]	1492 [878]	1454 [856]	1092 [642]	1068 [628]	2012 [1184]	1150 [677]	220 mm - 8,661 inch
3"	80,9	DN 80	4150 [2442]	4252 [2502]	4117 [2423]	2404 [1415]	1803 [1061]	2067 [1216]	2015 [1186]	1513 [890]	1480 [871]	2788 [1640]	1594 [938]	
4"	110,0	DN 100	7706 [4535]	7896 [4647]	7646 [4499]	4465 [2628]	3349 [1971]	3839 [2259]	3742 [2202]	2811 [1654]	2748 [1617]	5177 [3046]	2961 [1742]	
5"	133,7	DN 125	11399 [6708]	11679 [6873]	11309 [6655]	6605 [3887]	4954 [2915]	5679 [3342]	5535 [3257]	4157 [2446]	4065 [2392]	7657 [4506]	4379 [2577]	
6"	159,3	DN 150	16201 [9534]	16600 [9769]	16074 [9459]	9388 [5524]	7041 [4143]	8071 [4750]	7867 [4630]	5909 [3477]	5778 [3400]	10883 [6405]	6224 [3663]	300 mm - 11,811 inch
8"	200,0	DN 200	25599 [15065]	26229 [15436]	25397 [14946]	14833 [8729]	11125 [6547]	12753 [7505]	12431 [7315]	9337 [5494]	9130 [5373]	17196 [10120]	9835 [5788]	
10"	250,0	DN 250	40046 [23567]	41033 [24148]	39731 [23382]	23205 [13656]	17404 [10242]	19951 [11741]	19447 [11444]	14606 [8596]	14283 [8406]	26901 [15831]	15386 [9054]	
12"	300,0	DN 300	57736 [33977]	59158 [34814]	57281 [33710]	33455 [19688]	25091 [14766]	28764 [16927]	28037 [16499]	21058 [12393]	20593 [12119]	38784 [22824]	22182 [13054]	

* Nm³/h according to DIN 1343: 0 °C, 1013,25 hPa for gases

** ISO 1217: 20 °C, 1000 hPa in air

If you want to measure the consumption / flow rate of a specific gas mixture, ask us.
We can offer a real gas adjustment under process conditions on request.

Measuring ranges High-Speed version

Flow measuring ranges Flow Check Universal - insertion meter													
Inner pipe diameter			High-Speed version (224,0 m/s)										Recom- mended probe length
			Measuring range Nm ³ /h * / [cfm]										
Inch	mm	DN	Air**	Nitrogen (N ₂)	Argon (Ar)	Oxygen (O ₂)	Carbon dioxide (CO ₂)	Methane Natural gas (CH ₄)	Helium (He)	Hydrogen (H ₂)	Propane (C ₃ H ₈)		
1/2"	16,1	DN 15	110 [64]	101 [59]	172 [101]	105 [61]	109 [64]	65 [38]	46 [27]	32 [19]	50 [29]		
3/4"	21,7	DN 20	215 [126]	198 [116]	336 [198]	205 [120]	213 [125]	127 [74]	89 [52]	63 [37]	99 [58]		
1"	27,3	DN 25	356 [210]	328 [193]	557 [328]	340 [200]	353 [207]	211 [124]	149 [87]	104 [61]	164 [96]		160 mm
1 1/4"	36,0	DN 32	643 [378]	591 [348]	1006 [592]	613 [361]	636 [374]	380 [224]	268 [158]	188 [111]	295 [174]		6,299 inch
1 1/2"	41,9	DN 40	886 [521]	815 [479]	1385 [815]	845 [497]	877 [516]	524 [308]	370 [218]	260 [153]	407 [239]		
2"	53,1	DN 50	1450 [853]	1333 [784]	2267 [1334]	1382 [813]	1434 [844]	858 [504]	606 [356]	425 [250]	666 [392]		
2 1/2"	68,9	DN 65	2484 [1461]	2284 [1344]	3883 [2285]	2368 [1393]	2458 [1446]	1469 [865]	1038 [611]	729 [429]	1142 [672]		220 mm
3"	80,9	DN 80	3441 [2025]	3165 [1862]	5381 [3166]	3281 [1931]	3406 [2004]	2036 [1198]	1438 [846]	1010 [594]	1582 [931]		8,661 inch
4"	110,0	DN 100	6391 [3761]	5877 [3458]	9992 [5880]	6093 [3586]	6324 [3722]	3782 [2225]	2671 [1572]	1877 [1104]	2938 [1729]		
5"	133,7	DN 125	9453 [5563]	8693 [5116]	14780 [8698]	9012 [5304]	9355 [5505]	5594 [3292]	3951 [2325]	2776 [1633]	4346 [2558]		
6"	159,3	DN 150	13436 [7907]	12355 [7271]	21007 [12362]	12810 [7538]	13296 [7825]	7950 [4679]	5615 [3304]	3946 [2322]	6177 [3635]		300 mm
8"	200,0	DN 200	21229 [12493]	19522 [11489]	33192 [19533]	20240 [11911]	21009 [12363]	12562 [7393]	8873 [5221]	6235 [3669]	9761 [5744]		11,811 inch
10"	250,0	DN 250	33211 [19544]	30540 [17973]	51925 [30557]	31663 [18633]	32865 [19341]	19652 [11565]	13880 [8168]	9753 [5740]	15270 [8986]		
12"	300,0	DN 300	47880 [28177]	44030 [25912]	74861 [44055]	45649 [26864]	47383 [27885]	28333 [16674]	20012 [11777]	14062 [8275]	22015 [12956]		

Flow measuring ranges Flow Check Universal - insertion meter														
Inner pipe diameter			High-Speed version (224,0 m/s)										Recom- mended probe length	
			Measuring range Nm ³ /h * / [cfm]											
Inch	mm	DN	Corgon ®18	Corgon ®10	Corgon ®20	Forming gas 90% N ₂ + 10% H ₂	Natural gas L (CH ₄)	Biogas 50% CH ₄ + 50% CO ₂	Biogas 60% CH ₄ + 40% CO ₂	LPG 60% C ₃ H ₈ + 40% C ₄ H ₁₀	LPG 50% C ₃ H ₈ + 50% C ₄ H ₁₀	Nitrous (N ₂ O)	Ethylene/Acetylene (C ₂ H ₂)	
1/2"	16,1	DN 15	160 [94]	164 [96]	159 [93]	93 [54]	69 [41]	80 [47]	78 [45]	58 [34]	57 [33]	108 [63]	61 [36]	
3/4"	21,7	DN 20	314 [185]	322 [189]	311 [183]	182 [107]	136 [80]	156 [92]	152 [89]	114 [67]	112 [65]	211 [124]	120 [71]	160 mm
1"	27,3	DN 25	521 [306]	533 [314]	516 [304]	301 [177]	226 [133]	259 [152]	253 [148]	190 [111]	185 [109]	349 [205]	200 [117]	6,299 inch
1 1/4"	36,0	DN 32	939 [552]	962 [566]	932 [548]	544 [320]	408 [240]	468 [275]	456 [268]	342 [201]	335 [197]	631 [371]	360 [212]	
1 1/2"	41,9	DN 40	1294 [761]	1326 [780]	1284 [755]	749 [441]	562 [331]	644 [379]	628 [369]	472 [277]	461 [271]	869 [511]	497 [292]	
2"	53,1	DN 50	2117 [1245]	2169 [1276]	2100 [1236]	1226 [721]	920 [541]	1054 [620]	1028 [605]	772 [454]	755 [444]	1422 [836]	813 [478]	
2 1/2"	68,9	DN 65	3626 [2134]	3716 [2186]	3598 [2117]	2101 [1236]	1576 [927]	1806 [1063]	1761 [1036]	1322 [778]	1293 [761]	2436 [1433]	1393 [820]	220 mm
3"	80,9	DN 80	5025 [2957]	5149 [3030]	4985 [2934]	2911 [1713]	2183 [1285]	2503 [1473]	2440 [1436]	1832 [1078]	1792 [1054]	3375 [1986]	1930 [1136]	8,661 inch
4"	110,0	DN 100	9331 [5491]	9561 [5626]	9258 [5448]	5407 [3182]	4055 [2386]	4649 [2735]	4531 [2666]	3403 [2003]	3328 [1958]	6268 [3689]	3585 [2109]	
5"	133,7	DN 125	13802 [8122]	14142 [8322]	13693 [8058]	7997 [4706]	5998 [3530]	6876 [4046]	6702 [3944]	5034 [2962]	4923 [2897]	9271 [5456]	5302 [3120]	
6"	159,3	DN 150	19617 [11544]	20100 [11829]	19462 [11453]	11367 [6689]	8525 [5017]	9773 [5751]	9526 [5606]	7155 [4210]	6997 [4117]	13178 [7755]	7537 [4435]	300 mm
8"	200,0	DN 200	30996 [18241]	31759 [18690]	30752 [18097]	17960 [10569]	13470 [7927]	15442 [9087]	15051 [8858]	11305 [6653]	11055 [6506]	20821 [12253]	11908 [7008]	11,811 inch
10"	250,0	DN 250	48489 [28535]	49683 [29238]	48107 [28311]	28097 [16535]	21072 [12401]	24157 [14216]	23546 [13857]	17686 [10408]	17295 [10178]	32573 [19169]	18629 [10963]	
12"	300,0	DN 300	69907 [41140]	71629 [42153]	69357 [40816]	40508 [23839]	30381 [17879]	34828 [20496]	33947 [19978]	25498 [15005]	24934 [14674]	46961 [27636]	26858 [15806]	

* Nm³/h according to DIN 1343: 0 °C, 1013,25 hPa for gases

** ISO 1217: 20 °C, 1000 hPa in air

If you want to measure the consumption / flow rate of a specific gas mixture, ask us.
We can offer a real gas adjustment under process conditions on request.

Measuring ranges Flow Check

Measuring ranges Low-Speed version

Flow measuring ranges Flow Check												
Inner pipe diameter			Low-Speed version (50 m/s)									
			Measuring range Nm ³ /h * / [cfm]									
Inch	mm	DN	Air**	Nitrogen (N ₂)	Argon (Ar)	Oxygen (O ₂)	Carbon dioxide (CO ₂)	Methane Natural gas (CH ₄)	Helium (He)	Hydrogen (H ₂)	Propane (C ₃ H ₈)	
1/4"	8,9	DN 8	25 NI/min [0,9]	25 NI/min [0,9]	45 NI/min [1,5]	25 NI/min [0,9]	25 NI/min [0,9]	15 NI/min [0,6]	735 NI/h [0,3]	515 NI/h [0,3]	810 NI/h [0,3]	
1/2"	16,1	DN 15	20 [14,4]	20 [13,2]	35 [20]	20 [13,5]	20 [14,1]	240 NI/min [8,4]	170 NI/min [6]	120 NI/min [4,2]	185 NI/min [6,6]	
3/4"	21,7	DN 20	45 [25]	40 [25]	75 [40]	45 [25]	45 [25]	25 [15]	20 [11,7]	235 NI/min [8,1]	20 [12,9]	
1"	27,3	DN 25	75 [45]	70 [40]	120 [70]	75 [40]	75 [45]	45 [25]	30 [15]	20 [13,5]	35 [20]	
1 1/4"	36,0	DN 32	140 [80]	130 [75]	220 [130]	135 [80]	140 [80]	85 [50]	60 [35]	40 [20]	65 [35]	
1 1/2"	41,9	DN 40	195 [115]	180 [105]	305 [180]	185 [110]	195 [115]	115 [65]	80 [45]	55 [30]	90 [50]	
2"	53,1	DN 50	320 [190]	295 [175]	505 [295]	305 [180]	320 [185]	190 [110]	135 [75]	95 [55]	145 [85]	
2 1/2"	68,9	DN 65	550 [325]	505 [300]	865 [510]	525 [310]	545 [320]	325 [190]	230 [135]	160 [95]	250 [150]	
3"	80,9	DN 80	765 [450]	705 [415]	1200 [705]	730 [430]	760 [445]	450 [265]	320 [185]	225 [130]	350 [205]	

Flow measuring ranges Flow Check													
Inner pipe diameter			Low-Speed version (50 m/s)										
			Measuring range Nm ³ /h * / [cfm]										
Inch	mm	DN	Corgon ®18	Corgon 10	Corgon ®20	Forming gas 90% N ₂ + 10% H ₂	Natural gas L (CH ₄)	Biogas 50%CH ₄ + 50% CO ₂	Biogas 60% CH ₄ + 40% CO ₂	LPG 60% C ₃ H ₈ + 40% C ₄ H ₁₀	LPG 50% C ₃ H ₈ + 50% C ₄ H ₁₀	Nitrous (N ₂ O)	Ethyne/ Acetylene (C ₂ H ₂)
1/4"	8,9	DN 8	40 NI/min [1,5]	40 NI/min [1,5]	40 NI/min [1,5]	20 NI/min [0,6]	15 NI/min [0,6]	20 NI/min [0,6]	20 NI/min [0,6]	15 NI/min [0,3]	15 NI/min [0,3]	25 NI/min [0,9]	15 NI/min [0,3]
1/2"	16,1	DN 15	35 [20]	35 [20]	35 [20]	20 [12]	15 [9]	15 [10,5]	15 [10,2]	215 NI/min [7,5]	210 NI/min [7,5]	20 [14,1]	225 NI/min [8,1]
3/4"	21,7	DN 20	70 [40]	70 [40]	65 [40]	40 [20]	30 [15]	30 [20]	30 [20]	25 [15]	25 [14,7]	45 [25]	25 [15]
1"	27,3	DN 25	115 [65]	115 [70]	115 [65]	65 [35]	50 [25]	55 [30]	55 [30]	40 [20]	40 [20]	75 [45]	40 [25]
1 1/4"	36,0	DN 32	205 [120]	210 [125]	205 [120]	120 [70]	90 [50]	100 [60]	100 [55]	75 [45]	70 [40]	140 [80]	80 [45]
1 1/2"	41,9	DN 40	285 [170]	295 [170]	285 [165]	165 [95]	125 [70]	140 [80]	140 [80]	105 [60]	100 [60]	190 [110]	110 [65]
2"	53,1	DN 50	470 [275]	480 [280]	465 [275]	270 [160]	205 [120]	235 [135]	225 [135]	170 [100]	165 [95]	315 [185]	180 [105]
2 1/2"	68,9	DN 65	805 [475]	825 [485]	800 [470]	465 [275]	350 [205]	400 [235]	390 [230]	295 [170]	285 [165]	540 [320]	310 [180]
3"	80,9	DN 80	1120 [660]	1145 [675]	1110 [650]	645 [380]	485 [285]	555 [325]	540 [320]	405 [240]	400 [235]	750 [440]	430 [250]

* Nm³/h according to DIN 1343: 0 °C, 1013,25 hPa for gases

** ISO 1217: 20 °C, 1000 hPa in air

If you want to measure the consumption / flow rate of a specific gas mixture, ask us.
We can offer a real gas adjustment under process conditions on request.

Measuring ranges Standard version

Flow measuring ranges Flow Check											
Inner pipe diameter			Standard version (92,7 m/s)								
			Measuring range Nm ³ /h * / [cfm]								
Inch	mm	DN	Air**	Nitrogen (N ₂)	Argon (Ar)	Oxygen (O ₂)	Carbon dioxide (CO ₂)	Methane Natural gas (CH ₄)	Helium (He)	Hydrogen (H ₂)	Propane (C ₃ H ₈)
1/4"	8,9	DN 8	50 NI/min [1,8]	50 NI/min [1,5]	85 NI/min [3]	50 NI/min [1,8]	50 NI/min [1,8]	30 NI/min [0,9]	20 NI/min [0,6]	15 NI/min [0,3]	25 NI/min [0,6]
1/2"	16,1	DN 15	45 [25]	40 [20]	70 [40]	40 [25]	45 [25]	25 [15]	15 [11,1]	220 NI/min [7,8]	20 [12,3]
3/4"	21,7	DN 20	85 [50]	80 [45]	135 [80]	80 [45]	85 [50]	50 [30]	35 [20]	25 [15]	40 [20]
1"	27,3	DN 25	145 [85]	135 [75]	230 [135]	140 [80]	145 [85]	85 [50]	60 [35]	40 [25]	65 [35]
1 1/4"	36,0	DN 32	265 [155]	240 [140]	415 [245]	250 [145]	260 [155]	155 [90]	110 [65]	75 [45]	120 [70]
1 1/2"	41,9	DN 40	365 [215]	335 [195]	570 [335]	345 [205]	360 [210]	215 [125]	150 [90]	105 [60]	165 [95]
2"	53,1	DN 50	600 [350]	550 [320]	935 [550]	570 [335]	590 [345]	355 [205]	250 [145]	175 [100]	275 [160]
2 1/2"	68,9	DN 65	1025 [600]	945 [555]	1605 [945]	980 [575]	1015 [595]	605 [355]	425 [250]	300 [175]	470 [275]
3"	80,9	DN 80	1420 [835]	1305 [770]	2225 [1310]	1355 [795]	1405 [825]	840 [495]	595 [350]	415 [245]	650 [385]

Flow measuring ranges Flow Check													
Inner pipe diameter			Standard version (92,7 m/s)										
			Measuring range Nm ³ /h * / [cfm]										
Inch	mm	DN	Corgon ®18	Corgon ®10	Corgon ®20	Forming gas 90% N ₂ + 10% H ₂	Natural gas L (CH ₄)	Biogas 50% CH ₄ + 50% CO ₂	Biogas 60% CH ₄ + 40% CO ₂	LPG 60% C ₃ H ₈ + 40% C ₄ H ₁₀	LPG 50% C ₃ H ₈ + 50% C ₄ H ₁₀	Nitrous (N ₂ O)	Ethyne/ Acetylene (C ₂ H ₂)
1/4"	8,9	DN 8	75 NI/min [2,7]	80 NI/min [2,7]	75 NI/min [2,7]	45 NI/min [1,5]	30 NI/min [1,2]	35 NI/min [1,2]	35 NI/min [1,2]	25 NI/min [0,9]	25 NI/min [0,9]	50 NI/min [1,8]	30 NI/min [0,9]
1/2"	16,1	DN 15	65 [35]	65 [40]	65 [35]	35 [20]	25 [15]	30 [15]	30 [15]	20 [14,1]	20 [13,8]	40 [25]	25 [15]
3/4"	21,7	DN 20	130 [75]	130 [75]	125 [75]	75 [40]	55 [30]	60 [35]	60 [35]	45 [25]	45 [25]	85 [50]	45 [25]
1"	27,3	DN 25	215 [125]	220 [130]	210 [125]	120 [70]	90 [55]	105 [60]	100 [60]	75 [45]	75 [45]	140 [85]	80 [45]
1 1/4"	36,0	DN 32	385 [225]	395 [230]	385 [225]	225 [130]	165 [95]	190 [110]	185 [110]	140 [80]	135 [80]	260 [150]	145 [85]
1 1/2"	41,9	DN 40	535 [315]	545 [320]	530 [310]	310 [180]	230 [135]	265 [155]	260 [150]	195 [110]	190 [110]	355 [210]	205 [120]
2"	53,1	DN 50	875 [515]	895 [525]	865 [510]	505 [295]	380 [220]	435 [255]	425 [250]	315 [185]	310 [180]	585 [345]	335 [195]
2 1/2"	68,9	DN 65	1500 [880]	1535 [905]	1485 [875]	865 [510]	650 [380]	745 [440]	725 [425]	545 [320]	535 [315]	1005 [590]	575 [335]
3"	80,9	DN 80	2075 [1220]	2130 [1250]	2060 [1210]	1205 [705]	900 [530]	1035 [605]	1005 [590]	755 [445]	740 [435]	1395 [820]	795 [470]

* Nm³/h according to DIN 1343: 0 °C, 1013,25 hPa for gases

** ISO 1217: 20 °C, 1000 hPa in air

If you want to measure the consumption / flow rate of a specific gas mixture, ask us. We can offer a real gas adjustment under process conditions on request.

Measuring ranges Max version

Flow measuring ranges Flow Check												
			Max version (185,0 m/s)									
Inner pipe diameter			Measuring range Nm ³ /h * / [cfm]									
Inch	mm	DN	Air**	Nitrogen (N ₂)	Argon (Ar)	Oxygen (O ₂)	Carbon dioxide (CO ₂)	Methane Natural gas (CH ₄)	Helium (He)	Hydrogen (H ₂)	Propane (C ₃ H ₈)	
1/4"	8,9	DN 8	105 NI/min [3,6]	100 NI/min [3,3]	170 NI/min [6]	100 NI/min [3,6]	105 NI/min [3,6]	60 NI/min [2,1]	45 NI/min [1,5]	30 NI/min [0,9]	50 NI/min [1,5]	
1/2"	16,1	DN 15	90 [50]	80 [45]	140 [80]	85 [50]	90 [50]	50 [30]	35 [20]	25 [15]	40 [20]	
3/4"	21,7	DN 20	175 [100]	160 [95]	275 [160]	165 [95]	175 [100]	105 [60]	70 [40]	50 [30]	80 [45]	
1"	27,3	DN 25	290 [170]	270 [155]	460 [270]	280 [165]	290 [170]	170 [100]	120 [70]	85 [50]	135 [75]	
1 1/4"	36,0	DN 32	530 [310]	485 [285]	830 [485]	505 [295]	525 [305]	310 [185]	220 [130]	155 [90]	240 [140]	
1 1/2"	41,9	DN 40	730 [430]	670 [395]	1140 [670]	695 [410]	720 [425]	430 [250]	305 [180]	215 [125]	335 [195]	
2"	53,1	DN 50	1195 [700]	1100 [645]	1870 [1100]	1140 [670]	1185 [695]	705 [415]	500 [290]	350 [205]	550 [320]	
2 1/2"	68,9	DN 65	2050 [1205]	1885 [1110]	3205 [1885]	1955 [1150]	2030 [1190]	1210 [710]	855 [500]	600 [350]	940 [555]	
3"	80,9	DN 80	2840 [1670]	2610 [1535]	4440 [2615]	2710 [1590]	2810 [1655]	1680 [985]	1185 [695]	830 [490]	1305 [765]	

Flow measuring ranges Flow Check													
			Max version (185,0 m/s)										
Inner pipe diameter			Measuring range Nm ³ /h * / [cfm]										
Inch	mm	DN	Corgon ®18	Corgon ®10	Corgon ®20	Forming gas 90% N ₂ + 10% H ₂	Natural gas L (CH ₄)	Biogas 50% CH ₄ + 50% CO ₂	Biogas 60% CH ₄ + 40% CO ₂	LPG 60% C ₃ H ₈ + 40% C ₄ H ₁₀	LPG 50% C ₃ H ₈ + 50% C ₄ H ₁₀	Nitrous (N ₂ O)	Ethyne/ Acetylene (C ₂ H ₂)
1/4"	8,9	DN 8	155 NI/min [5,4]	160 NI/min [5,7]	155 NI/min [5,4]	90 NI/min [3]	65 NI/min [2,4]	75 NI/min [2,7]	75 NI/min [2,7]	55 NI/min [1,8]	55 NI/min [1,8]	105 NI/min [3,6]	60 NI/min [2,1]
1/2"	16,1	DN 15	130 [75]	135 [80]	130 [75]	75 [45]	55 [30]	65 [35]	60 [35]	45 [25]	45 [25]	85 [50]	50 [30]
3/4"	21,7	DN 20	255 [150]	265 [155]	255 [150]	150 [85]	110 [65]	125 [75]	125 [70]	90 [55]	90 [50]	170 [100]	95 [55]
1"	27,3	DN 25	430 [250]	440 [255]	425 [250]	245 [145]	185 [110]	210 [125]	205 [120]	155 [90]	150 [90]	285 [170]	165 [95]
1 1/4"	36,0	DN 32	775 [455]	795 [465]	765 [450]	445 [260]	335 [195]	385 [225]	375 [220]	280 [165]	275 [160]	520 [305]	295 [175]
1 1/2"	41,9	DN 40	1065 [625]	1095 [640]	1060 [620]	615 [360]	460 [270]	530 [310]	515 [305]	385 [225]	380 [220]	715 [420]	410 [240]
2"	53,1	DN 50	1745 [1025]	1790 [1050]	1730 [1020]	1010 [595]	755 [445]	870 [510]	845 [495]	635 [375]	620 [365]	1170 [690]	670 [395]
2 1/2"	68,9	DN 65	2995 [1760]	3065 [1805]	2970 [1745]	1735 [1020]	1300 [765]	1490 [875]	1450 [855]	1090 [640]	1065 [625]	2010 [1180]	1150 [675]
3"	80,9	DN 80	4150 [2440]	4250 [2500]	4115 [2420]	2400 [1415]	1800 [1060]	2065 [1215]	2015 [1185]	1510 [890]	1480 [870]	2785 [1640]	1590 [935]

* Nm³/h according to DIN 1343: 0 °C, 1013,25 hPa for gases

** ISO 1217: 20 °C, 1000 hPa in air

If you want to measure the consumption / flow rate of a specific gas mixture, ask us.
We can offer a real gas adjustment under process conditions on request.

Measuring ranges High-Speed version

Flow measuring ranges Flow Check												
Inner pipe diameter			High-Speed version (224,0 m/s)									
			Measuring range Nm ³ /h * / [cfm]									
Inch	mm	DN	Air**	Nitrogen (N ₂)	Argon (Ar)	Oxygen (O ₂)	Carbon dioxide (CO ₂)	Methane Natural gas (CH ₄)	Helium (He)	Hydrogen (H ₂)	Propane (C ₃ H ₈)	
1/4"	8,9	DN 8	130 NI/min [4,5]	120 NI/min [4,2]	205 NI/min [7,2]	125 NI/min [4,2]	130 NI/min [4,5]	75 NI/min [2,7]	55 NI/min [1,8]	35 NI/min [1,2]	60 NI/min [2,1]	
1/2"	16,1	DN 15	110 [60]	100 [55]	170 [100]	105 [60]	105 [60]	65 [35]	45 [25]	30 [15]	50 [25]	
3/4"	21,7	DN 20	215 [125]	195 [115]	335 [195]	205 [120]	210 [125]	125 [70]	85 [50]	60 [35]	95 [55]	
1"	27,3	DN 25	355 [210]	325 [190]	555 [325]	340 [200]	350 [205]	210 [120]	145 [85]	100 [60]	160 [95]	
1 1/4"	36,0	DN 32	640 [375]	590 [345]	1005 [590]	610 [360]	635 [370]	380 [220]	265 [155]	185 [110]	295 [170]	
1 1/2"	41,9	DN 40	885 [520]	815 [475]	1385 [815]	845 [495]	875 [515]	520 [305]	370 [215]	260 [150]	405 [235]	
2"	53,1	DN 50	1450 [850]	1330 [780]	2265 [1330]	1380 [810]	1430 [840]	855 [500]	605 [355]	425 [250]	665 [390]	
2 1/2"	68,9	DN 65	2480 [1460]	2280 [1340]	3880 [2285]	2365 [1390]	2455 [1445]	1465 [865]	1035 [610]	725 [425]	1140 [670]	
3"	80,9	DN 80	3440 [2025]	3165 [1860]	5380 [3165]	3280 [1930]	3405 [2000]	2035 [1195]	1435 [845]	1010 [590]	1580 [930]	

Flow measuring ranges Flow Check													
Inner pipe diameter			High-Speed version (224,0 m/s)										
			Measuring range Nm ³ /h * / [cfm]										
Inch	mm	DN	Corgon ®18	Corgon ®10	Corgon ®20	Forming gas 90% N ₂ + 10% H ₂	Natural gas L (CH ₄)	Biogas 50% CH ₄ + 50% CO ₂	Biogas 60% CH ₄ + 40% CO ₂	LPG 60% C ₃ H ₈ + 40% C ₄ H ₁₀	LPG 50% C ₃ H ₈ + 50% C ₄ H ₁₀	Nitrous (N ₂ O)	Ethyne/ Acetylene (C ₂ H ₂)
1/4"	8,9	DN 8	190 NI/min [6,6]	195 NI/min [6,9]	190 NI/min [6,6]	110 NI/min [3,9]	80 NI/min [2,7]	95 NI/min [3,3]	90 NI/min [3,3]	70 NI/min [2,4]	65 NI/min [2,4]	125 NI/min [4,5]	70 NI/min [2,4]
1/2"	16,1	DN 15	160 [90]	160 [95]	155 [90]	90 [50]	65 [40]	80 [45]	75 [45]	55 [30]	55 [30]	105 [60]	60 [35]
3/4"	21,7	DN 20	310 [185]	320 [185]	310 [180]	180 [105]	135 [80]	155 [90]	150 [85]	110 [65]	110 [65]	210 [120]	120 [70]
1"	27,3	DN 25	520 [305]	530 [310]	515 [300]	300 [175]	225 [130]	255 [150]	250 [145]	190 [110]	185 [105]	345 [205]	200 [115]
1 1/4"	36,0	DN 32	935 [550]	960 [565]	930 [545]	540 [320]	405 [240]	465 [275]	455 [265]	340 [200]	335 [195]	630 [370]	360 [210]
1 1/2"	41,9	DN 40	1290 [760]	1325 [780]	1280 [755]	745 [440]	560 [330]	640 [375]	625 [365]	470 [275]	460 [270]	865 [510]	495 [290]
2"	53,1	DN 50	2115 [1245]	2165 [1275]	2100 [1235]	1225 [720]	920 [540]	1050 [620]	1025 [605]	770 [450]	755 [440]	1420 [835]	810 [475]
2 1/2"	68,9	DN 65	3625 [2130]	3715 [2185]	3595 [2115]	2100 [1235]	1575 [925]	1805 [1060]	1760 [1035]	1320 [775]	1290 [760]	2435 [1430]	1390 [820]
3"	80,9	DN 80	5025 [2955]	5145 [3030]	4985 [2930]	2910 [1710]	2180 [1285]	2500 [1470]	2440 [1435]	1830 [1075]	1790 [1050]	3375 [1985]	1930 [1135]

* Nm³/h according to DIN 1343: 0 °C, 1013,25 hPa for gases

** ISO 1217: 20 °C, 1000 hPa in air

If you want to measure the consumption / flow rate of a specific gas mixture, ask us.
We can offer a real gas adjustment under process conditions on request.



Measure compressed air consumption and save energy

Compressed air is one of the most expensive forms of energy at all. An intelligent use of compressed air holds enormous savings potential.

Therefore a consumption measurement that can measure and record the actual compressed air consumption and even the smallest leaks quickly and reliably is very helpful.



When talking about operating costs in compressed air systems, one actually means the energy costs, because the electricity costs make up about 70-80% of the total cost of a compressed air system.

Depending on the size of the plant this means considerable operating costs. Even in smaller plants this may quickly add up to 10,000 to 20,000 € per year. This is an amount which can be considerably reduced – even in case of well operated and maintained plants.

In case of a three shift operation with 200 kW compressor performance a bad compressed air distribution can create redundant energy costs of more than 50,000 € per year.

This mainly relates to the detection of leaks and the correct design of the compressed air lines to minimize the pressure losses.

Energy resources like electricity, water or gas are usually monitored and therefore the costs are transparent.

Contrary to compressed air, a water leak is usually found quickly due to the visibility of the leak and therefore is fixed immediately. Leakages in the compressed air network „blow out“ unnoticed, even on weekends and during production stops.

Also during that time compressors are running continuously in order to establish a constant pressure within the system. In case of compressed air systems which have grown during the years the leakage rate can be between 25 and 35 per cent.

They are the most industrious consumers working 365 days a year.

Not considered in these considerations are the costs of producing clean and dry compressed air. Refrigeration and desiccant dryers dry the air with significant operating costs, which then „blow out“ useless through leaks.

At constantly rising energy costs these potential energy savings have to be implemented in order to stay competitive within the market. Only if the consumption of single machines or plants becomes known and transparent for all it is possible to make use of possible savings.

However, often there is no knowledge about the leak ratio. In the following we show you how leakage rate can be determined easily in your company.

Formerly the simple but inaccurate container method was applied very often.

A simplified determination of the leakages is possible by means of the emptying of the tank.

To carry out this measurement you just need a clock and a manometer. Furthermore you should know the storage volume of the tank as well as of the compressed air system.

For measurement first the tank and the compressed air system are set to the upper cut-out pressure value. All compressed air consumers have to be switched off.

Then the compressor is switched off and there will be no compressed air feeding into the system.

Now the time T is measured which passes by until there is a pressure drop of 1 to 2 bar due to the leakages.

The pressure drop between which the measurement is taking place can be selected freely.

However, in practice the described method is very time-consuming, not adequate and inaccurate due to the following reasons:

- Storage volume, distribution pipelines cannot be determined exactly
- The accuracy of the differential pressure measurement and time measurement has to be observed
- During pressure drop the compressed air volume cools down and therefore it changes the volume flow reference value
- An online measurement with consumption record is not possible

This method belongs to the so-called indirect measurements, like also the method of the load and unload measurement during which the current intake is measured by means of clamp-on ammeters and calculated back to the volume flow over the technical data of the compressor.

These indirect methods are antiquated and not suitable to detect leakages in the lower measuring range.

Determination of compressed air leakages with modern flow meters

A modern compressed air consumption measurement resp. leakage measurement should be able to measure the real compressed air flow and also the smallest leakages quickly and reliably and record them.

New: Flow measurement Flow Check S3/ S4 for compressed air and gases

Worldwide unique with 3.5 inch, graphic display with touch screen and print function.

With the new "ready for plug-in" flow measurement Flow Check S3/ S4 the current flow in m³/h, l/min etc. as well as the consumption in m³ or l can be measured.

The new flow station works according to the approved calorimetric measuring principle.



The heart is the flow sensor which has been proven and tested for years.

It is characterized by a new thermally more efficient sensor structure which shows a higher chip temperature in case of same electrical connection values.

Compared to other calorimetric measuring instruments the sensor has a considerably lower mass and therefore a faster response time.

An additional pressure and temperature compensation is not necessary.

The advantage is that the user can use the flow meters in different pressures and temperatures without any further compensation.

Apart from compressed air also other gases like e. g.

- **Nitrogen**
- **Oxygen**
- **CO₂**
- **Argon**
- **Natural gas**
- **Helium**

can be measured.

The flow meter DS 400 is supplied completely wired. There is no need for a time consuming instruction manual reading.

Exceeding of threshold values can be reported optically and acoustically. 2 relays for pre- and main alarm are freely adjustable.



An alarm delay can be set for each relay. This grants that only really long-term exceeding of the threshold values are indicated. Additionally every alarm can be reset.

The intuitive operation with the 3.5 inch touch screen graphic display with zoom function and print key is worldwide unique in this price class.

The graphic display with zoom function shows the actual flow, the peak values and the leakage at a glance, the values are stored in the data logger.

So the user can take a look at the stored measuring curves also without any computer at any time on site.

This allows the user to view the stored measured curves without a PC at any time on site.

With the print button, the current screen can be saved as an image file on the internal SD card or on a USB stick and can be printed out without additional software on a PC.

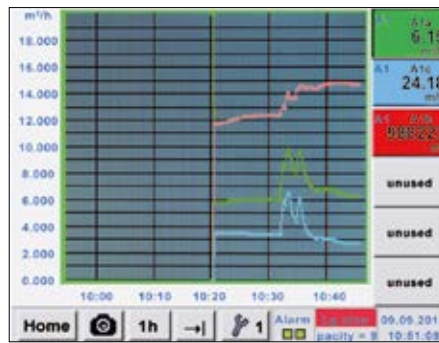

Ideal for documentation of the measured values/ curves on site. Colored measured curves can be sent by e-mail as image files or integrated into a service report.

The internal data logger enables the storage of the measured data for several years. The measured data can be evaluated via a USB stick or via Ethernet by means of the comfortable software PMH Soft Basic.

Particularly comfortable is the consumption analysis at the touch of a button. The PMH Soft Basic automatically draws up daily, weekly and monthly reports.

Special features

- 3.5" graphic display, intuitive operation via touch screen
- Zoom function for accurate analysis of measured values
- Consumption analysis with daily/weekly/monthly reports
- Colored measured curves with names
- Mathematical calculation function e. g. addition of several consumers to a total consumption or energy costs per kWh/m³
- Print key: Optional indications can be stored as image files directly on a USB stick and sent by e-mail without any software
- 2 alarm contacts for exceeding of threshold values
- Freely adjustable alarm delay for both alarm contacts
- With reset function
- Up to 4 sensor inputs for: Further flow sensors, dew point, pressure, temperature, consumption, active power meters, optional third-party sensors can be
- Connected: Pt100/1000, 0/4..20 mA, 0-1/10 V,
- Modbus, pulse
- Integrated data logger 8 GB
- USB, Ethernet interface, RS 485
- Webserver

Installation Flow Check Universal under pressure



Flow Check Universal flow meter for compressed air and gases

The Flow Check Universal flow meter is installed via a standard ball valve under pressure. The circlip prevents the instrument from being ejected during installation and removal by the operating pressure.

For the installation at different pipe diameters, the Flow Check Universal can be ordered at special lengths: 120, 160, 220, 300, 400 mm. Therefore it is possible to use the Flow Check Universal flow sensor from inner pipe diameters of 1/2" up to 12" and bigger.

The exact positioning of the sensor is carried out with the aid of the engraved depth scale at the sensors shaft. The maximum insertion depth is therefore determined by the sensor length. Please see picture to determine the sensor length required.

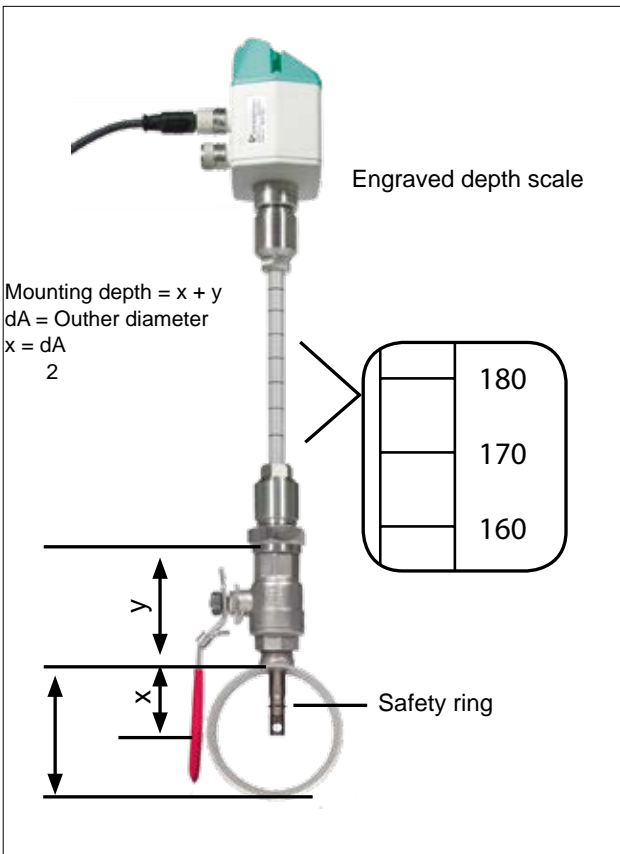

Measuring site

If no 1/2" ball valve is present to carry out the installation of the Flow Check Universal sensor, we have two possible alternatives to offer:

- A** 1/2"-thread needs to be welded onto the pipe work and the ball valve is then threaded on.
- B** A spot drilling collar can be ordered and installed.

Making use of the specialized drilling jig, it is then possible to drill a whole into the pipe work under load. The filings are caught in a special filter system at the drilling jig. Afterwards the Flow Check Universal probe should be installed as described above.

The Flow Check Universal measuring range allows for measurements in almost all possible applications. Even high flow rates in small pipe diameters can be measured.

Leak Check Pro 1/ Pro 2 - Leak detector with camera - indicates leakage rate in l/min and costs in €

The LD 500 meets the requirements of Class I „Standard Test Method for Leaks with ultrasound“ (ASTM Int. - E1002-5)



Find out your leak rate (l/min) and potential saving (€/year)



Find the smallest leaks in far distance



Auto level: adapts the sensitivity automatically to the environment and eliminates the ambient noise reliably



Photograph leaking parts



Describe the leak and necessary actions



Transmit the leak details via USB to your desktop software



Create an ISO 50001 report



Seek the leak the whole day (9 hours)

Costs per year						
Pressure	Leak size - Diameter (mm)					
	0,5 mm	1,0 mm	1,5 mm	2,0 mm	2,5 mm	3,0 mm
3 bar	90 €	361 €	812 €	1.444 €	2.256 €	3.248 €
4 bar	113 €	451 €	1.015 €	1.805 €	2.820 €	4.061 €
5 bar	135 €	541 €	1.218 €	2.166 €	3.384 €	4.873 €
6 bar	158 €	632 €	1.421 €	2.527 €	3.948 €	5.685 €
7 bar	180 €	722 €	1.624 €	2.888 €	4.512 €	6.497 €
8 bar	203 €	812 €	1.827 €	3.248 €	5.076 €	7.309 €

Table: Leakage costs within one year in case of operation 24 h/365 days, calculated with compressed air costs of 1.9 ct/Nm³.

Leak Check Pro 1/ Pro 2 is a consistent advancement

The new leak meters Leak Check Pro 1/ Pro 2 with integrated camera and leakage calculation are ideal measuring instruments which help to find and document even smallest leakages (0.1 l/min corresponds to approx. 1 € per year) easily even in far distances.

Leak Check Pro 2 is the worldwide first leak meter with an additional freely assignable sensor input for all PMH sensors. In addition to the leakage measurement and detection also all necessary measurements with regards to dew point, flow, pressure, and temperature ... can be carried out.



Leak detection at:

- Compressed air, gas, steam and vacuum systems
- Steam Traps
- Seals



The noise-proof headset enables the leak detection also in EXTREMELY loud ambient. The ambient noise will be faded out, the leakage (inaudible ultrasonic sound) will be transformed to an audible signal. The laser grants an exact locating.

Accessories



Acoustic trumpet

bundles the acoustic waves of smallest leakages, disturbing ambient noise will be eliminated



Focus tube with focus tip for precise locating of smallest leakages in narrow areas



Optionally available:

Gooseneck enables a positioning of the leakage on the spot – even in case of hardly accessible locations. Noise is hidden.



Parabolic mirror:

for leak detection at long distances. Laser pointer and camera integrated.

Professional accessory parabolic mirror

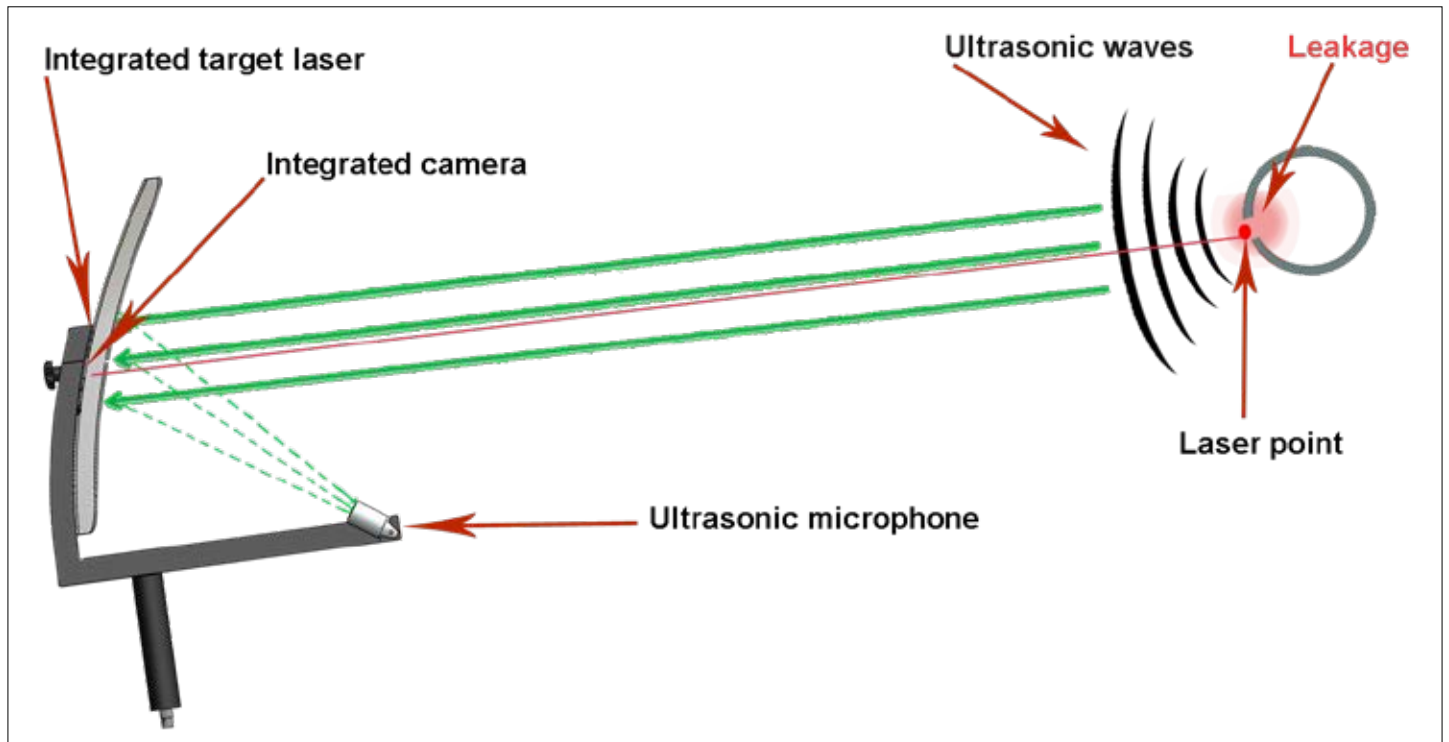

By bundling the ultrasonic waves in the parabolic mirror, even the smallest leaks of 0.8 l / min (ca. 8 € p.a.) at a distance of up to 10 ... 15 m can be localized with pinpoint accuracy (± 15 cm). The shape of the parabolic mirror ensures that only ultrasonic waves of the targeted leak are evaluated. Disterbing noise is reduced to a minimum.



Accurate leak detection during operation with laser pointer and integrated camera



Checking high voltage overhead lines for corona discharge



Leakage files stored in Leak Check Pro 1/ Pro 2 are exported to a USB stick for issuing a report by software

If the leakage is detected and stored, the following data are also stored in the Leak Check Pro 1/ Pro 2 and will be available after the export to the PMH Leak Reporter software to issue a report:



- Photo of the leakage
- Date / time
- Company name / department / machine
- Size of the leakage in liters/min (unit selectable)
- Costs of the leakage per year in € (currency selectable)

Detailed reports can be issued via PC software, which can be placed at the disposal of the operators of compressed air systems resp. the head of the respective department.

The report can be issued for the whole company or for each department and it documents the detected leakages easily and clearly. Due to the summation at the end of the report it is easy to get an overview on the whole leakage amount in liters/min as well as the total leakage costs per year.

Leak Tags in hardcopies for documentation on-site

Leakage - report for ISO 50001 Audits

Image	Building	Place	Leak Tag	Date	Time	Volume loss	Costs / Year	CO2 loss / Year	Comment	action	measure	Responsible	Status	Priority
	Neuer	Gartenweg 2	Flansch Nr. 2-DH	04.04.2018	11:28:42	10.549 l/min	100.36 €	0.38	SEALING					
	Neuer	Gartenweg 2	Machine 23	04.04.2018	11:31:18	21.828 l/min	214.96 €	1.19	Coupling					
	Neuer	Gartenweg 2	Machine 23	04.04.2018	11:32:51	2.997 l/min	29.83 €	0.17	Piping					
							Σ 36.68	Σ 200.17	Σ 1.94					

DESCRIPTION	ORDER NO.
Set Leak Check Pro 1 consisting of:	2255331710
Leak Check Pro 1 leak detector with acoustic trumpet, and integrated camera, 100 leak tags for marking the leakages on site	2255332718
Transportation case	2255332719
Sound-proof headset	2255332720
Focus tube with focus tip	2255332721
AC adapter plug	2255332722
Helix cable for connecting the ultrasonic sound sensor, length 2 m, (extended)	2255332723
Set Leak Check Pro 2 consisting of:	2255332456
Leak Check Pro 2 leak detector incl. acoustic trumpet, with integrated camera and additional input for external sensors, 100 leak tags for marking the leakages on site	2255332724
Transportation case	2255332719
Sound-proof headset	2255332720
Focus tube with focus tip	2255332721
AC adapter plug	2255332722
Helix cable for connecting the ultrasonic sound sensor, length 2 m, (extended)	2255332723
Equipment:	
PMH Leak Reporter – for detailed ISO 50001 reports. Gives an illustrated survey of the found leakages and their possible savings. Measures for elimination including status display can be defined for every leakage - License for 2 computers	2255332459
Gooseneck for leakage detection at sites which are difficult to access (length 600 mm)	2255332460
Gooseneck for leakage detection at sites which are difficult to access (length 1500 mm)	2255332729
Parabolic mirror for leak detection at long distances, incl. Transportation case	2255332461
Ultrasonic tone generator for leak testing	2255332725
500 leak tags for marking the leakages on site	2255332726
Calibration:	
Recalibration Leak Check Pro 1/ Pro 2	2255332727
Further sensors / accessories for connection to Leak Check Pro 2:	
PDP Sens 1/2 dew point sensor for mobile devices, -80...+20°Ctd, incl. mobile measuring chamber, 5 m connection cable and perforated protection cap	2255332526
Flow sensor Flow Check Universal , Max version (185 m/s) sensor length 220 mm, incl. 5 m connection cable	2255332524
Standard pressure sensor PMH 16, 0...16 bar, ± 1 % accuracy of f. s	2255330414
Differential pressure sensor 1.6 bar diff.	2255332486
Connection cable for pressure, temperature or external sensors on mobile instruments, ODU / open ends, 5 m	2255332514
PMH Basic - data evaluation in graphic and table form - reading out of the measured data via USB Stick Ethernet. License for 2 computers	2255332468



Transportation case Leak Check Pro 1/ Pro 2



Transportation case with Parabolic mirror

TECHNICAL DATA Leak Check Pro 1/ Pro 2	
Working frequency:	40 kHz ± 2 kHz
Connections:	3.5 mm stereo jack for headset Power supply socket for connecting an external recharger
Laser:	Wave length: 645...660 nm Output power: < 1 mW (laser class 2)
Display:	3,5" Touch screen
Interface:	USB interface
Data logger	8 GB SD memory card (100 million values)
Power supply:	Internal rechargeable Li-Ion batteries approx. 9 h continuous operation, 4 h charging time
Ambient temperature:	0...+50°C
EMC:	DIN EN 61326
Auto level:	Adapts the sensitivity automatically to the environment and eliminates the ambient noise reliably
Sensitivity:	min: 0.1 l/min at 6 bar, 5 m distance, approx. 1€/year compressed air costs

TECHNICAL DATA EXTERNAL SENSOR INPUT (ONLY Leak Check Pro 2)	
Measuring range:	Please see external PMH sensors
Accuracy:	Please see external PMH sensors
Voltage supply:	Output voltage: 24 VDC ± 10% Output current: 120 mA in continuous operation

Leak detector Leak Check

If gases escape through leaks in piping systems (e.g. untight screwed connections, corrossions and so on) ultrasonic noises are generated. By means of Leak Check even the smallest leakages which cannot be heard by the human ear and which are not visible due to their size can be detected even from distances of

several meters. Leak Check transforms the inaudible signals into a frequency which can be identified. By means of the comfortable sound-proof headset these noises can be realized even in extremely noisy environments.

The Leak Check leak detector convinces by its obviously refined sensor technology and

its improved support in the tracing of leaks. By means of the integrated laser pointer which serves for target heading the leak can be localized more accurately.

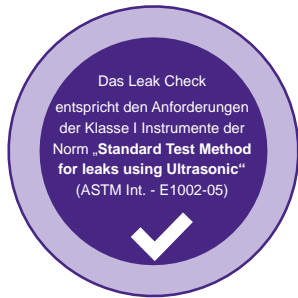

Applications

Leak detection in:

- Compressed air lines, gas, vapor and vacuum plants
- Door seals



Leak Check with focus tube and focus tip for precise locating.



↑
Acoustic trumpet

Sound-proof headset enables:
leak detection in extremely noisy environments

Costs per year						
Pressure	Leak size - Diameter (mm)					
	0,5 mm	1,0 mm	1,5 mm	2,0 mm	2,5 mm	3,0 mm
3 bar	90 €	361 €	812 €	1.444 €	2.256 €	3.248 €
4 bar	113 €	451 €	1.015 €	1.805 €	2.820 €	4.061 €
5 bar	135 €	541 €	1.218 €	2.166 €	3.384 €	4.873 €
6 bar	158 €	632 €	1.421 €	2.527 €	3.948 €	5.685 €
7 bar	180 €	722 €	1.624 €	2.888 €	4.512 €	6.497 €
8 bar	203 €	812 €	1.827 €	3.248 €	5.076 €	7.309 €

Table: Leakage costs within one year in case of operation 24 h/365 days, calculated with compressed air costs of 1.9 ct/Nm³.

Through the use of a specially designed trumpet, a better bundling of the sound waves is achieved. This trumpet acts like a directional microphone, suppressing unwanted noise and facilitating the pinpoint location of leaks even in hard-to-reach areas. Due to the special design of the bell, the use of the laser pointer is not hin-

dered. A handy ultrasonic transmitter is available for detecting leaks in pressureless systems. The transmitter is positioned so that the sound can enter the piping system. The ultrasonic signal penetrates the smallest openings, which can then be detected with the Leak Check.

Even very small leaks at hatches, doors and windows can be detected.

Special features

- Robustness and low weight ensure fatigue-free use in industrial environments
- Improved detection of leaks with optional acoustic trumpet
- Modern lithium-ion battery with high capacity, external recharger
- Minimum operating time 10 h
- Easy operation via keypad



Leak Check is available either as standalone device or in a complete set. The set includes a robust impact-proof transportation case which contains all necessary components and accessories.

DESCRIPTION	ORDER-NR.
Set Leak Check consisting of:	2255330400
Leak Check Leak detector	2255332730
Transport case	2255332719
Sound-proof headset	2255332720
Focus tube with focus tip	2255332721
Battery charger	2255332722
Acoustic trumpet	2255332728
Accessory, not included in the set:	
Ultrasonic tone generator	2255332725

TECHNICAL DATA Leak Check	
Working frequency:	40 kHz ± 2 kHz
Connections:	3.5 mm stereo jack for headset. Power supply socket for connecting a external recharger
Laser:	wave length: 645...660 nm output power: < 1 nW (laser class 2)
Operating duration:	10 hours
Charging time:	approx. 1.5 hours
Operating temp.:	0 to 40 °C
Storage temp.:	-10 °C to 50 °C



PMH Basic

With the PMH Basic the paperless recorder Check Box S6/ Check Box S1-S5 and all mobile devices with data logger can be read out. Depending on the device, data transfer is done either via USB stick or Ethernet connection.

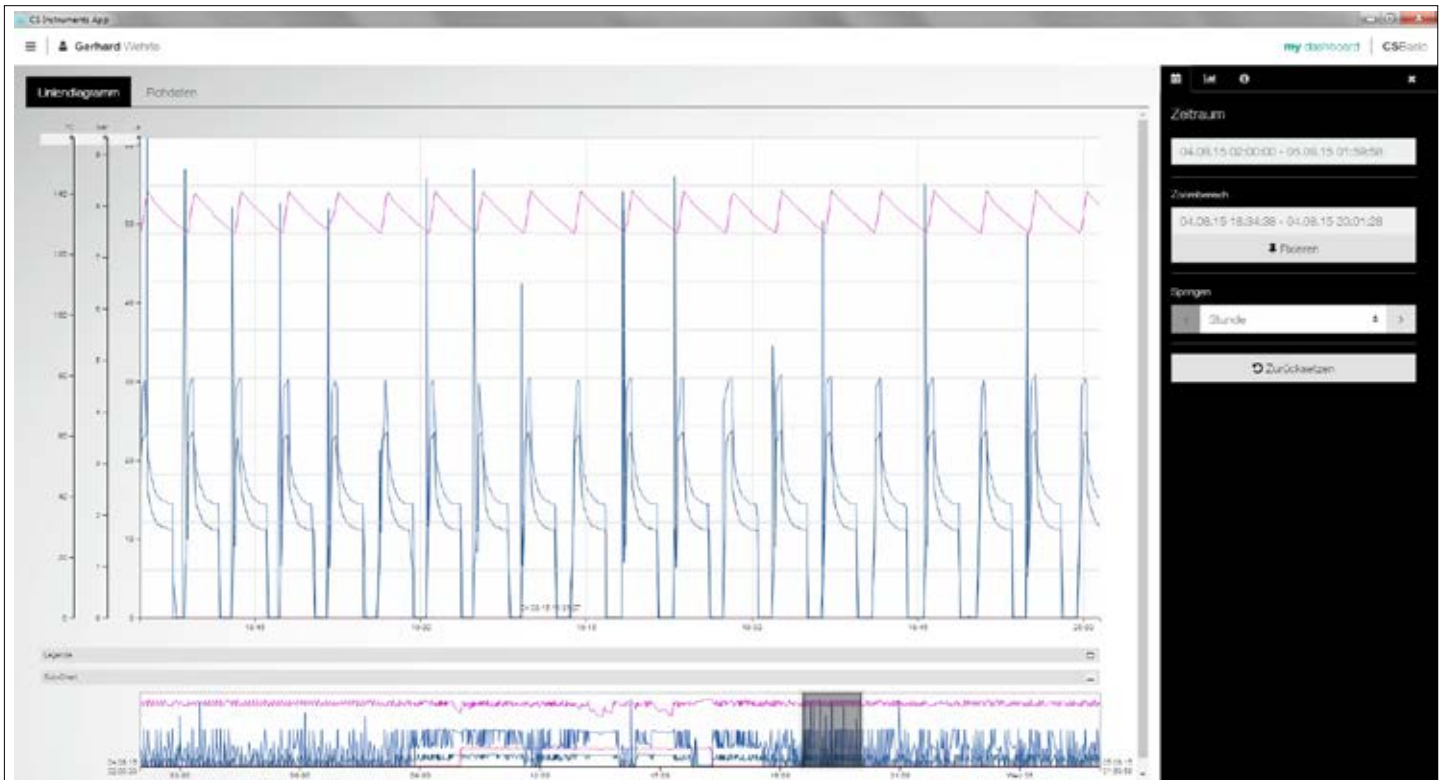

	PMH Basic
Installation	Local PC installation
Data storage	Database (local)
Updates to new releases free of charge	Yes
Automatic information about upgrades	Yes (only in case of internet access)
Number of working place licenses	2
Number of measured values	All measured values transmitted by a device. (Max. 1 device at the same time)
Data transfer	USB Stick (manually) or Ethernet
User administration	No
E-Mail in case of threshold value exceeding	No
Storage of the measured data	Logger data have to be read-out manually via PMH Basic

Functions:

Graphic evaluation

All measuring curves are indicated in color. All necessary functions are integrated, like e. g. free zoom, selection/deselection of single measuring curves, free selection of periods, scaling of the axis, select colors and so on. This view can be stored as a PDF file and sent by e-mail. Different data can be combined in one common file.

Table view

All measuring points are listed with exact time interval. The desired measuring channels with the name of the measuring place can be selected via the diagram explorer.

Statistics

All required statistic data are visible at a glance. So the user can see very quickly which minimal or maximal measured values occurred when and for how long.

Consumption report

The software issues a consumption report for all connected flow sensors, it can be selected if it should be daily, weekly or monthly.

Data export to MS-Excel® or csv

The measured data can be exported to Excel or csv.

Tariffes

The price per consumption unit can be can be stored for each energy form. Depending on the time and the day different tariffs can be stored. The validity of the tariffs can be defined via calendar function in order to grant that price increased resp. decreases can be updated.

Multi lingual

German, english and further languages are included in the scope of delivery.

Alarm history / Alarm logfile

The exceeding of the limit values is documented with the PMH Network.

Administration of the measuring sites

Each PMH sensor resp. each PMH chart recorder can be allocated to a department/hall (resp. cost centers).

Optional add-on modules:

Module „formular-editor“

By means of the formula editor e. g. the measured values of 2 sensors can be totaled or subtracted from each other.



PMH Basic

Data evaluation for mobile measurement:

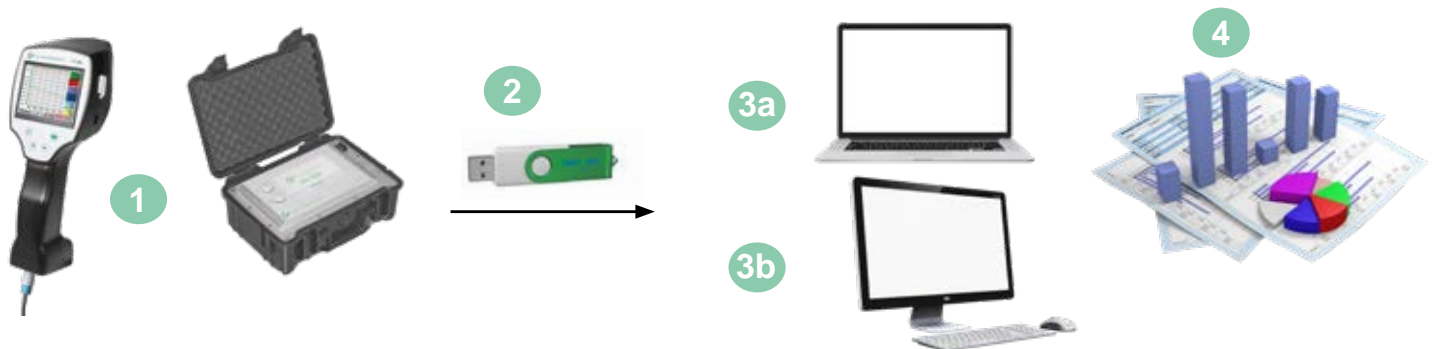

- 1 Mobile measurement at the customer. Measured data are saved in the data logger in the selected measuring cycle
- 2 Export of the data to the USB stick
- 3a Import of the measured data to the laptop directly on-site
- 3b Import of the measured data to the computer in the office
- 4 Evaluation and print out of the measured data

Data evaluation for fix installed chart recorder in the company:

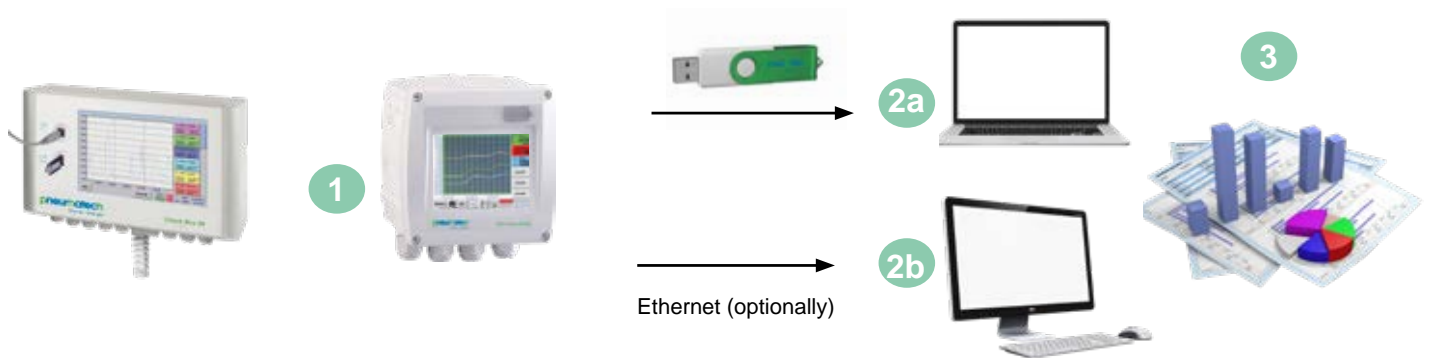

- 1 Chart recorder is fix installed in the company. Measured data will be saved in the data logger in the selected measurement cycle
- 2a Transfer the data via USB stick to the computer
- 2b Readout of the logger data via the computer network (LAN) by means of PMH Basic
- 3 Evaluation and print out of the measured data

DESCRIPTION	ORDER-NR.
PMH Basic - data evaluation in graphic and table form - readout of the measured data via USB or Ethernet. License for 2 working places	2255332468
Additional license for 1 further working place	2255332735
Module „Formula Editor“ – by means of the formula editor the measured data and constants can be calculated (addition, subtraction, division, multiplication, root function, exponentiation)	2255332736

PMH Basic

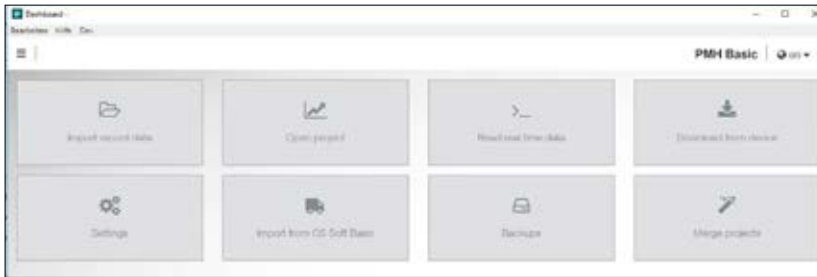

Intuitive operation

All important functions can be retrieved via the dashboard.

- Global Settings: Adjust units and change decimal places, store company name and logo
- Import real-time data: Establish Ethernet connection to PMH logger or sensor. Trace real-time measured data in graphic and in table form
- Import from PMH Soft Basic: Data migration from the previous version of PMH Soft Basic
- Data backup: Backup of the projects and the database

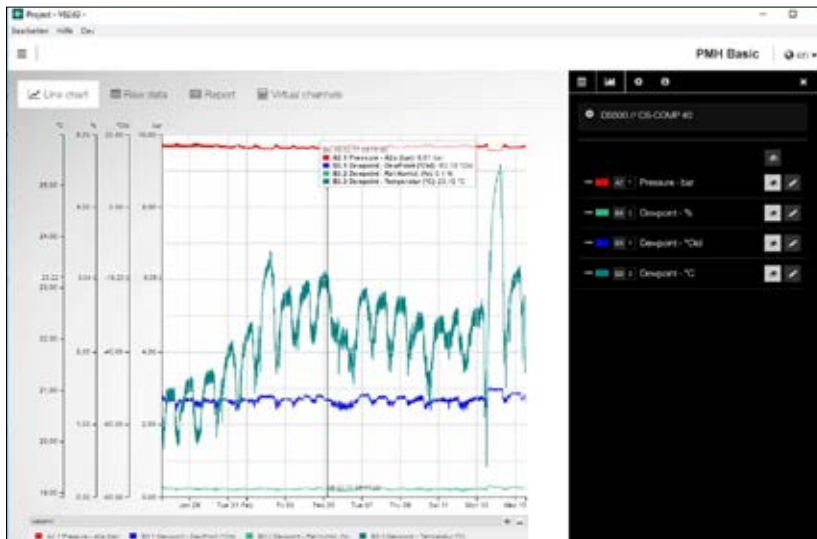

Graphic evaluation

All measurement curves are indicated in terms of color. All necessary functions like free zoom, selection/deselection of single measured curves, free selection of periods, scaling of the axes, selection of colors and so on are integrated: This view can be stored as pdf file and sent by e-mail. Different data can be merged to one common file.

Date	Device	A2.1	B3.1	B3.2	B3.3
		Pressure A2a bar	Dewpoint DewPoint °Ctd	Rel.Humid. %	Temperatur °C
27.01.17 13:52:18	0	9,6749	-50,6462	0,1534	20,2556
27.01.17 13:52:28	0	9,676	-51,4187	0,1394	20,2517
27.01.17 13:52:38	0	9,6769	-52,0952	0,128	20,2499
27.01.17 13:52:48	0	9,678	-52,791	0,1173	20,2479

Table view

All measuring points are listed with the exact time interval. The desired measuring channels with the measuring site name can be selected via the diagram explorer.

Channel	Average	Minimum	Date of minimum	Maximum	Date of maximum
A2.1 Pressure - A2a (bar)	9.6519 bar	9.61 bar	13.02.17 13:29:45	9.6391 bar	13.02.17 13:29:08
B3.2 Dewpoint - Rel.Humid. (%)	0.1094 %	0.0895 %	13.02.17 14:40:23	0.4119 %	13.02.17 14:30:08
B3.1 Dewpoint - DewPoint (°Ctd)	-53.2794 °Ctd	-57.9552 °Ctd	27.01.17 13:54:38	-41.6251 °Ctd	13.02.17 14:38:08

Statistics

All necessary statistical PMH data are apparent at a glance. So the user can quickly see which minimum or maximum measured values occurred at which time and for how long.

	January	February	March	April	May	June	July	August	September	October	November	December	Sum
A1.2 Start (m³)	1,958,527	2,075,325	2,215,062	2,308,484	2,514,612	2,666,480	2,826,483	3,002,938	3,169,484	3,318,642	3,491,601	3,659,617	3,659,617
Verbrauch (m³)													
End (m³)	2,076,325	2,215,062	2,308,484	2,514,612	2,666,480	2,826,483	3,002,938	3,169,484	3,318,642	3,491,601	3,659,617	3,775,973	
Consumption (m³)	117,498	138,737	153,422	146,148	151,868	160,003	176,455	186,546	149,158	173,019	167,966	116,366	1,817,146
Cost (€)	2,232,49	2,636,00	2,914,04	2,779,81	2,880,49	3,040,09	3,352,60	3,104,37	2,834,00	3,287,36	3,191,16	2,210,76	34,523,774
A1.1 Minimum (m³/h)	0	0,2	0	0	0	1,36	0	0	0	0	0	0	
Verbrauch (m³/h)													
Average (m³/h)	157,6	205,96	205,8	200,54	203,52	201,66	206,5	203,25	206,67	202,19	202,67	155,99	
Maximum (m³/h)	1,060,36	527,02	736,39	1,154	662,43	618,27	617,9	636,36	931,66	642,96	669,77	2,410,71	

Flow evaluation

The software carries out flow analysis for all connected flow sensors optionally as daily, weekly or monthly report.



Pneumatech reserves the right to change or revise specifications and product design in connection with any features of our products. Such changes do not entitle the buyer to corresponding changes, improvements, additions or replacements for equipment previously sold or shipped.

© 2019 Pneumatech. All rights reserved.

